



# BX2913

## 2022-2024 Ford Maverick HEV

(Includes Adaptive Cruise Control, Shuttters & Hybrid)

### Installation Instructions

Please read **BOTH** these Installation Instructions and the General Information sheet prior to installing or operating this equipment.

Serial Number

Attachment Tab Height: 14"

Attachment Tab Width: 26"

Please ensure tow bar being used is compatible with the baseplate tab width.

- Blue Ox® towing products and accessories are intended to be installed by Blue Ox® Dealers who are familiar with our products and have the equipment and knowledge necessary to do "fit work". If needed, Blue Ox® Dealers can be found at [www.blueox.com](http://www.blueox.com) or by contacting our Customer Care Department at (402) 385-3051.
- Many Blue Ox® baseplates are designed to use existing holes and hardware to mount the baseplate to the towed vehicle. Even though bolts are there, do not assume they are adequate for baseplate mounting. Always use the hardware supplied in the hardware kit and existing hardware as specified in the installation instructions.

#### Bolt Torque Specifications

Torque in Foot-Pounds for Inch Bolts

Bolt Size	Grade 5	Grade 8
1/4"	10	14
5/16"	19	29
3/8"	33	47
7/16"	54	78
1/2"	78	119
5/8"	154	230
3/4"	257	380

#### Bolt Torque Specifications

Torque in Foot-Pounds for Metric Bolts

Bolt Size	Grade 8.8	Grade 10.9
6MM	6	8
8MM	16	22
10MM	31	40
12MM	54	70
14MM	89	117
16MM	161	230
18MM	222	318



If the front of your vehicle looks different than this, please contact us at (402)385-3051.

Reference your vehicle owner's manual for manufacturer's towing specifications.



## WARNING

Failure to read and follow these instructions could result in separation of the towed vehicle from the tow bar, causing property damage, loss of towed vehicle, personal injury or death.

BX2913  
2022-2024 Ford Maverick HEV  
(Includes Adaptive Cruise Control, Shuttles & Hybrid)  
Installation Instructions

**Instruction Notes:** The fascia and windshield washer fluid reservoir are removed and reinstalled for the baseplate installation. Some drilling and trimming is required.

Place all components that are removed on a flat, sturdy surface. All items will be reinstalled unless otherwise noted after the baseplate is installed.

The dimensional variations between otherwise identical vehicles can be considerable. While the baseplate was designed for easy installation, it may be necessary to tailor the baseplate slightly to compensate for vehicle manufacturer's tolerances.

The BX8869 Tail Light Wiring Kit is recommended for vehicles without LED lights and the BX8848 Tail Light Wiring Kit is recommended for vehicles with LED.

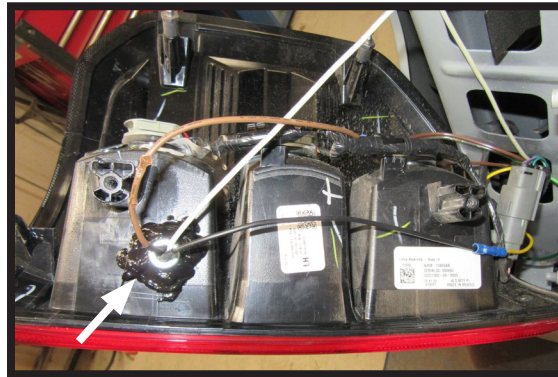

Drill a hole according to the tail  
light wiring kit instructions.

## **NOTICE**

- Handling of some cosmetic parts when installing this product may require the use of protective covers, rags, specialty tools, etc. to prevent damage.
- When using power drills be aware of the dangers of torque and drill bit length.
- When using a reciprocating saw be aware of objects behind the cutting surface.
- Use a good quality paint to spray cut edges of frame to prevent rusting.
- Be sure that **ALL** electrical connections are plugged in and accessories are functioning properly before reinstalling the fascia.
- The baseplate is computer tested to your vehicle's GVWR, exceeding this weight will void the manufacturer's warranty.
- Be sure to use a sufficient amount of Loctite® Red on all bolt threads before tightening. Tighten all bolts according to the torque chart provided unless specified.
- Dealer or installer be certain the user receives these instruction sheets.
- If the baseplate is in an accident, it must be replaced. **DO NOT** use it again! An accident can cause unseen damage and using it again could result in more damage or serious injury. **DO NOT** use the baseplate if it is damaged or missing parts.

BX2913  
2022-2024 Ford Maverick HEV  
(Includes Adaptive Cruise Control, Shuttters & Hybrid)  
Installation Instructions

<b>Tools Required</b>	
Large Vise Grip	7MM Socket
Flat Screwdriver	8MM Socket
Level	10MM Deep Socket
Reciprocating Saw	10MM Socket
Torque Wrench	11MM Socket
Drill	11MM Wrench
Tape Measure	13MM Socket
Loctite® RED	16MM Socket
3/8" Drill Bit	3/4" Socket
1/2" Drill Bit	3/4" Wrench
T20 Torx	T30 Torx

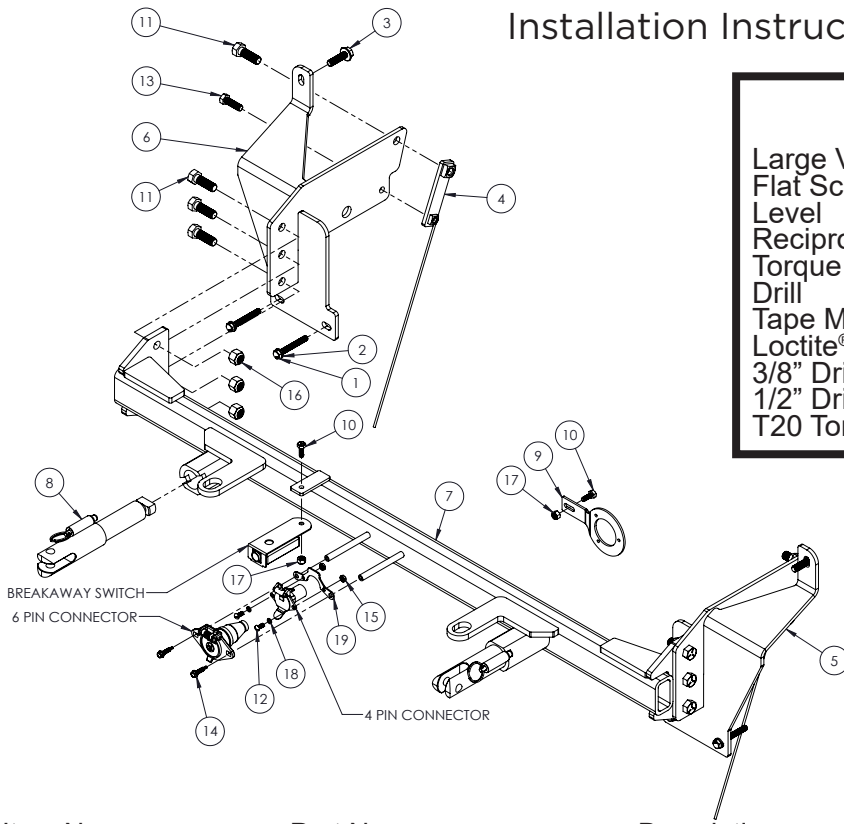

Item No.	Part No.	Description	Qty.
1.....	Existing.....	M8-1.25MM x 60MM Long.....	4
2.....	Existing.....	8MM Flat Washer.....	4
3.....	Existing.....	M10-1.5MM x 35MM Long.....	2
4.....	61-8344.....	Nut Plate w/ 2 Holes.....	2
5.....	61-8743.....	BX2913 Baseplate, DS.....	1
6.....	61-8744.....	BX2913 Baseplate, PS.....	1
7.....	61-8745.....	BX2913 Baseplate, Center.....	1
8.....	62-3469.....	Attachment Tab Assembly with Hole.....	2
9.....	101-11212.....	Pedestrian Sensor Bracket Plate.....	1
10.....	201-0050.....	1/4"-20 x 3/4" Hex Head Bolt, Grade 5, ZP.....	2
11.....	201-0051.....	1/2"-13 x 1-1/2" Hex Head Bolt, Grade 5.....	8
12.....	201-0192.....	#10-32 1/2" Round Slotted Head Screw.....	2
13.....	201-0368.....	3/8"-16 x 1-1/4" Hex Head Bolt, Grade 5, ZP.....	2
14.....	201-0979.....	#12-14 x 1" Self Drilling Screw, ZP.....	2
15.....	202-0047.....	#10-32 Hex Nut.....	2
16.....	202-0094.....	1/2"-13 Hex Nylon Insert Lock Nut, ZP.....	6
17.....	202-0102.....	1/4"-20 Hex Nylon Nut, ZP.....	2
18.....	203-0054.....	#10 Lock Washer, ZP.....	2
19.....	299-0685.....	Electrical Bracket.....	1
20.....	226-0049(not shown).....	Class IV Safety Cables.....	2
21.....	229-0512(not shown).....	1/2" Quicklink, ZP.....	2
22.....	290-0275(not shown).....	8" Nylon Cable Tie.....	3
23.....	290-0437(not shown).....	Black Cap Plug Receiver.....	2

**Important:**

Use only genuine factory replacement parts on your baseplate. Do **NOT** substitute homemade or non-typical parts. If a bolt is lost or in need of replacement, for your safety and the preservation of your baseplate, be sure to use a replacement bolt of the same grade (In most cases it will be Grade 5, please reference the parts list above). Replacement parts may be ordered through your nearest Blue Ox® Dealer or Distributor. Failing to follow and/or altering these installation instructions in either installation or required equipment will void the manufacturer's warranty. Towing behind a non-motorized vehicle will void the warranty.

BX2913  
2022-2024 Ford Maverick HEV  
(Includes Adaptive Cruise Control, Shuttters & Hybrid)  
Installation Instructions

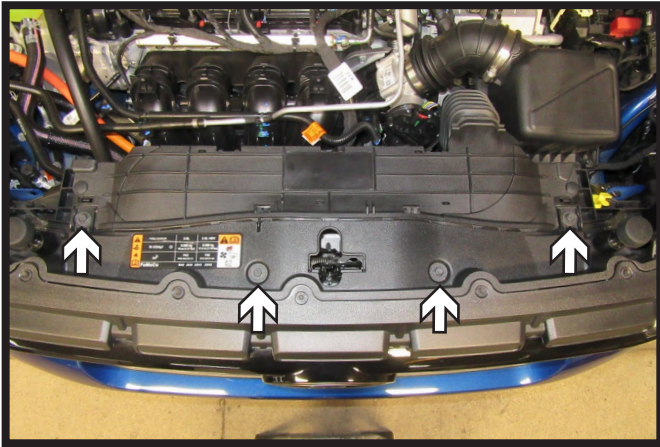

1. Using a 10MM socket, remove the four (4) bolts from the top of the fascia.

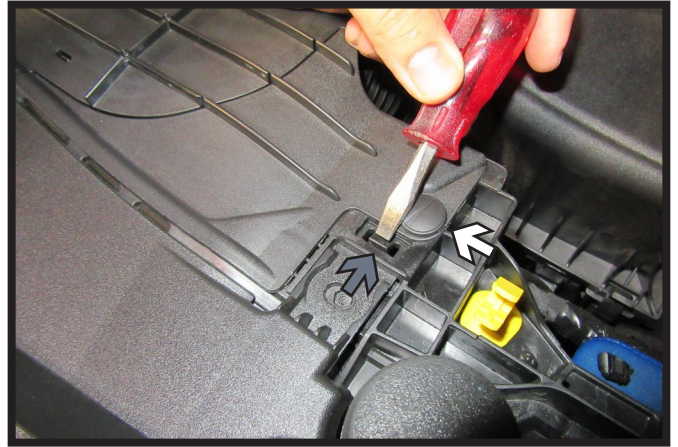

2. Remove the one (1) push pin (white) from the top of the fascia. Then using a flat screw driver, push down on the hook (gray) to release. Do this on both sides of the vehicle.

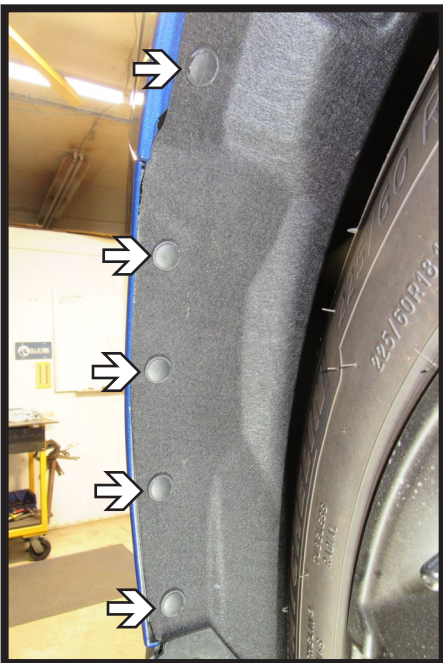

3. Remove the five (5) push pins from the wheel well edge. Do this on both sides of the vehicle.



4. Using a 7MM socket, remove the three (3) bolts (gray) and one (1) push pin (white) from the wheel well edge. Do this on both sides of the vehicle.

BX2913  
2022-2024 Ford Maverick HEV  
(Includes Adaptive Cruise Control, Shuttters & Hybrid)  
Installation Instructions

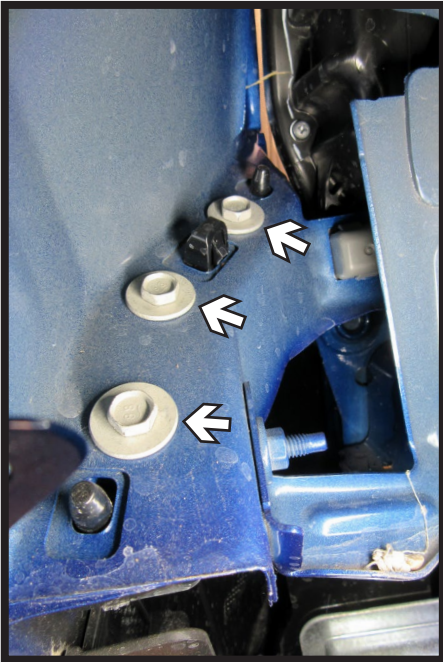

5. Pull back the wheel well liner. Using a 10MM socket, remove the three (3) bolts from the fascia joint. Do this on both sides of the vehicle.

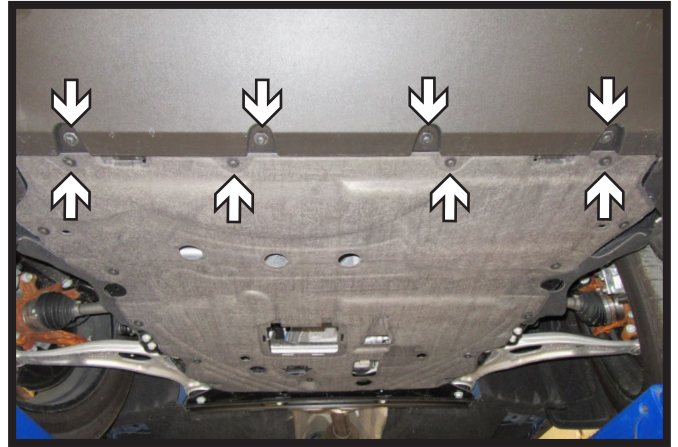

6. Using a T30 Torx, remove the eight (8) bolts from the underside of the fascia.



7. As the fascia is removed, unplug electrical connection on the passenger side of the vehicle. Set fascia aside to be reinstalled later.

BX2913  
2022-2024 Ford Maverick HEV  
(Includes Adaptive Cruise Control, Shutters & Hybrid)  
Installation Instructions

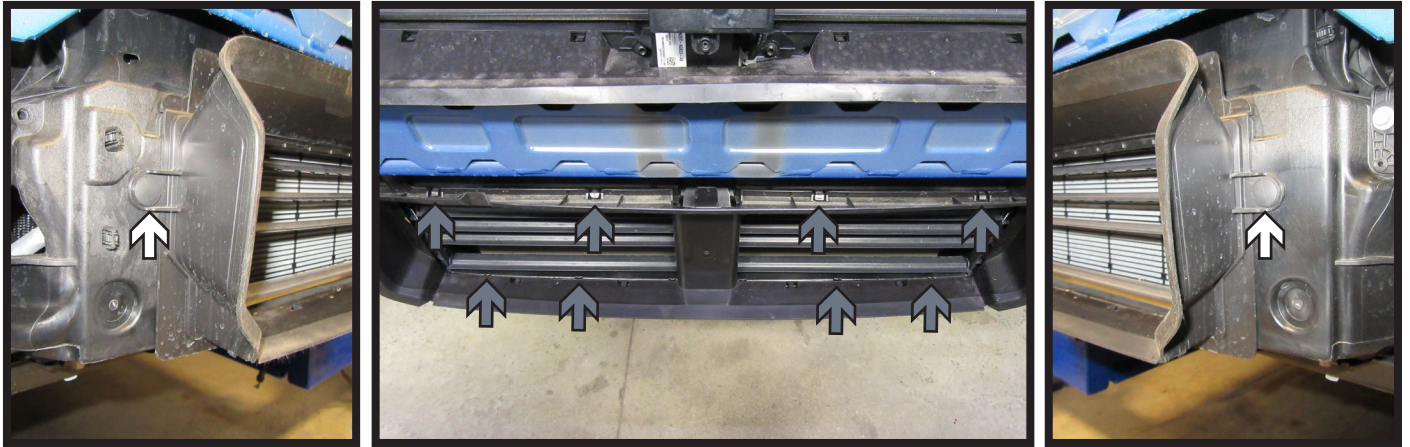

8. Remove the two (2) push pins (white), one (1) on each side of the shroud around the lower shutters. Then using a flat screw driver, release the eight (8) clips around the edge of the shroud (gray). Remove shroud and set aside to be reinstalled later.

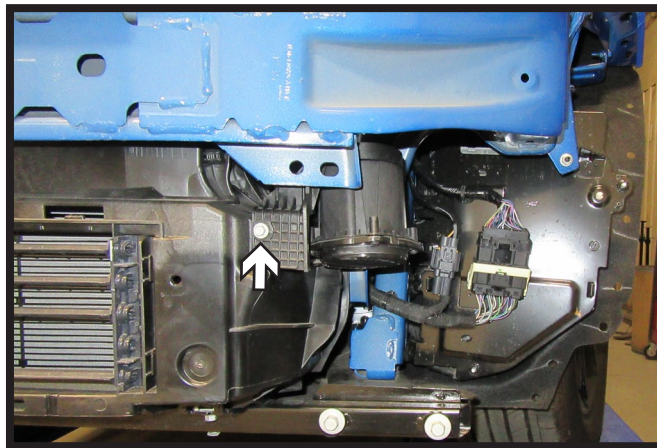

9. Using a 8MM socket, remove the one (1) bolt from the speaker mounting bracket on the driver side of the vehicle. Unplug electrical on the back of the speaker. Remove the pedestrian alert speaker and set aside to be reinstalled later.

BX2913  
2022-2024 Ford Maverick HEV  
(Includes Adaptive Cruise Control, Shutters & Hybrid)  
Installation Instructions

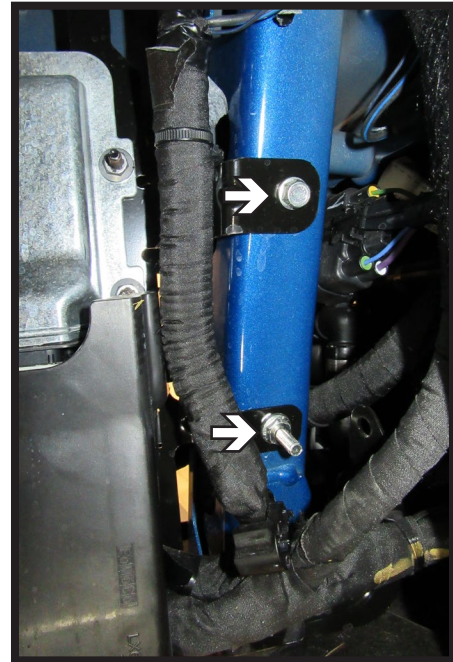
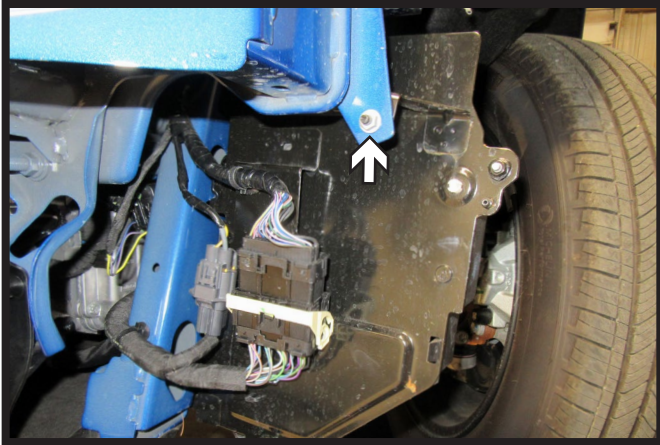

10. Using a 10MM socket, remove the one (1) nut from the top of the black box in front of the wheel on the driver side of the vehicle (left). Then remove the wire loom from the backside bottom bolt. Using a 10MM deep socket, remove the two (2) bolts from the backside (right). Let box hang out of the way for baseplate installation.

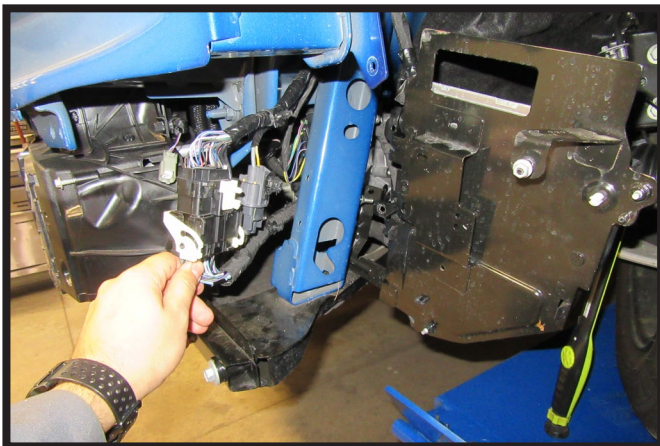

11. Unclip the electrical and wire loom from the front of the black box and the front of the frame on the driver side of the vehicle.

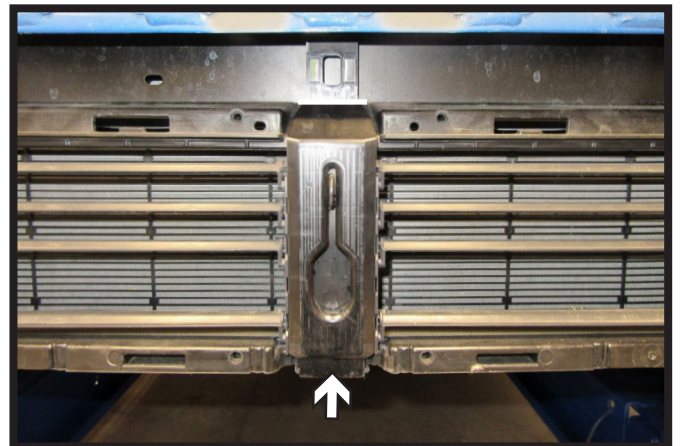

12. Using a reciprocating saw, cut the top of the shutter center piece as shown. Then remove the remaining center piece cover.

BX2913  
2022-2024 Ford Maverick HEV  
(Includes Adaptive Cruise Control, Shutters & Hybrid)  
Installation Instructions



13. Using a reciprocating saw, cut the shutters as indicated to allow for baseplate clearance.  
**Note: Be careful not to accidentally cut the wires on the back side of the shutters on the passenger side of the vehicle.**

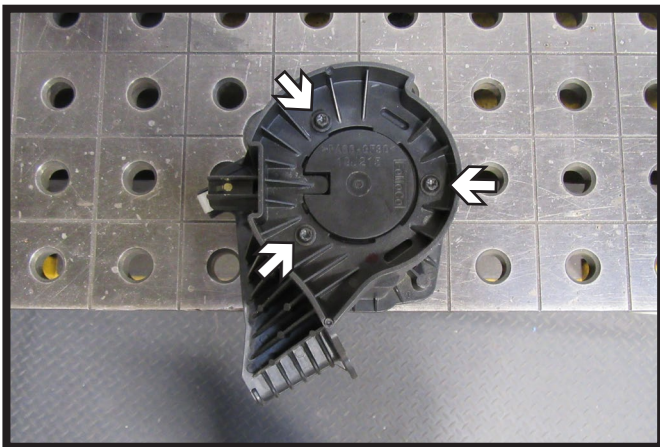

14. Using a T20 Torx, remove the three (3) bolts from the bottom of the pedestrian alert speaker. Remove the mounting bracket from the speaker.

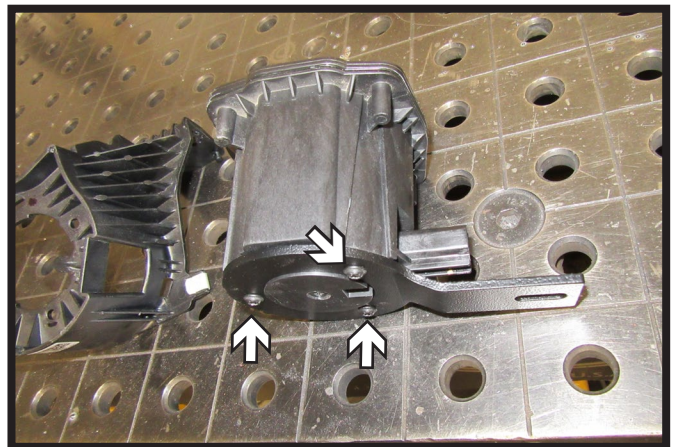

15. Using the existing bolts, attach the provided new mounting bracket to the bottom of the speaker as shown.



BX2913  
2022-2024 Ford Maverick HEV  
(Includes Adaptive Cruise Control, Shuttters & Hybrid)  
Installation Instructions

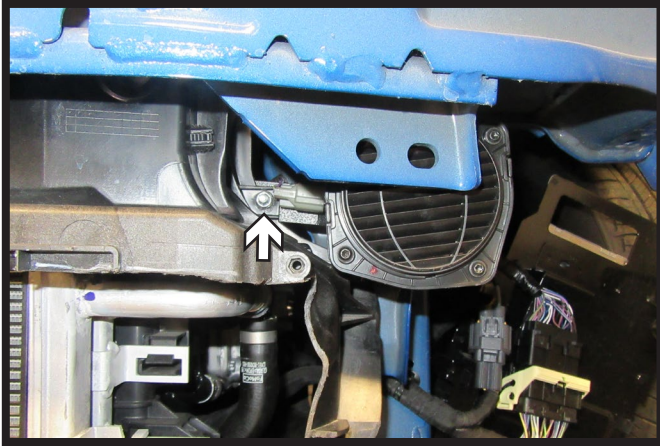

16. Reinstall the pedestrian alert speaker on the driver side of the vehicle. Start the provided 1/4" x 3/4" bolt with nylon nut. Ensure the speaker is as high and towards the center of the vehicle as possible then tighten bolt.

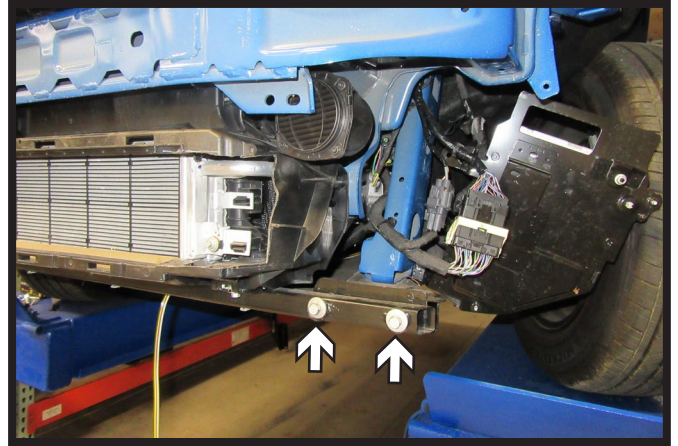

17. Using a 13MM socket, remove the two (2) bolts from the bottom of the frame on the driver side of the vehicle.



18. Using a 16MM socket, remove the one (1) bolt from behind the bumper on the driver side of the vehicle.

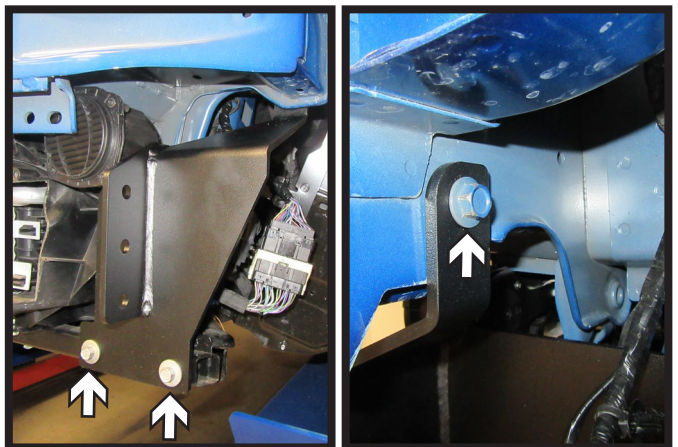

19. Slide the baseplate bracket onto the driver side of the vehicle and reinstall the two (2) M8 bolts with washers (left) and one (1) M10 bolt. Leave loose.

**Repeat steps 17-19 on the passenger side of the vehicle.**

BX2913  
2022-2024 Ford Maverick HEV  
(Includes Adaptive Cruise Control, Shuttters & Hybrid)  
Installation Instructions

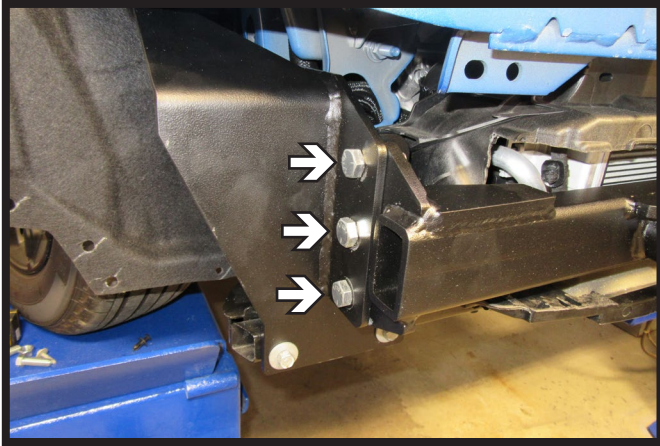

20. Slide the baseplate center piece into place. Install six (6) 1/2" bolts with nylon lock nuts, three (3) on each side. Ensure the center tube is level then tighten all bolts at this time.

**\*\* Use Loctite® Red on all bolt threads and tighten all bolts to the appropriate torque. \*\***

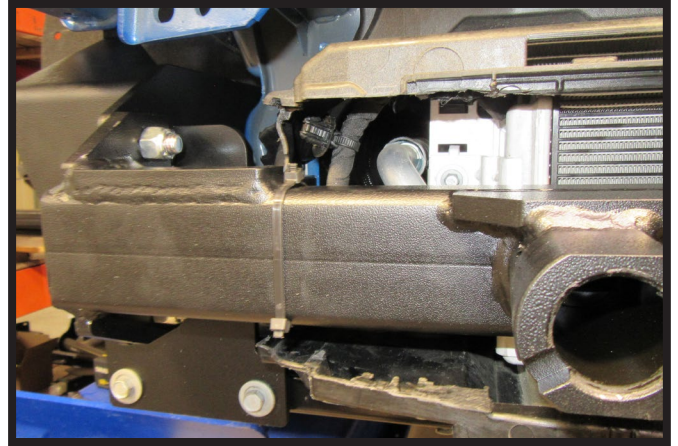

21. Using the provided zip ties, secure the wire loom on the passenger side of the vehicle to the back of the baseplate as shown. Ensure the wire loom is as far away from the radiator tubes as possible.

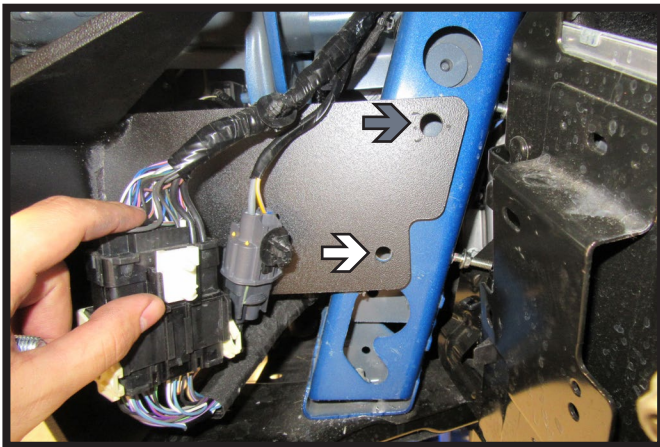

22. Using a 3/8" drill bit, drill out the back bottom hole (white) using the baseplate as a template. If needed use a 1/2" drill bit, ream out the back top hole (gray). Do this on both sides of the vehicle.

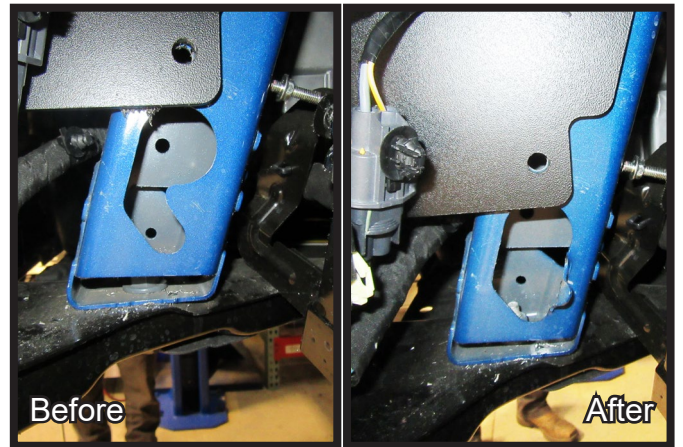

23. Using a pair of large vise grips bend back the frame piece as shown to create an access hole for the nut plate. Do this on both sides of the vehicle.

BX2913  
2022-2024 Ford Maverick HEV  
(Includes Adaptive Cruise Control, Shuttters & Hybrid)  
Installation Instructions

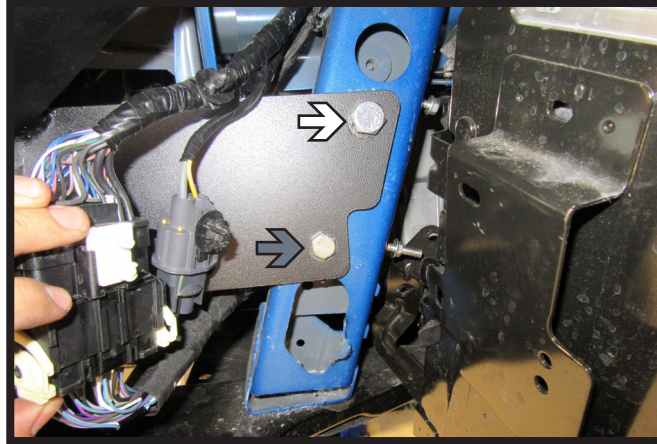

24. Insert nut plate through hole in the frame. Insert a 1/2" bolt into the top hole (white) and a 3/8" bolt into the bottom hole (gray). Bend frame piece back into place. Tighten all bolts. Do this on both sides of the vehicle.

**\*\* Use Loctite® Red on all bolt threads and tighten all bolts to the appropriate torque. \*\***

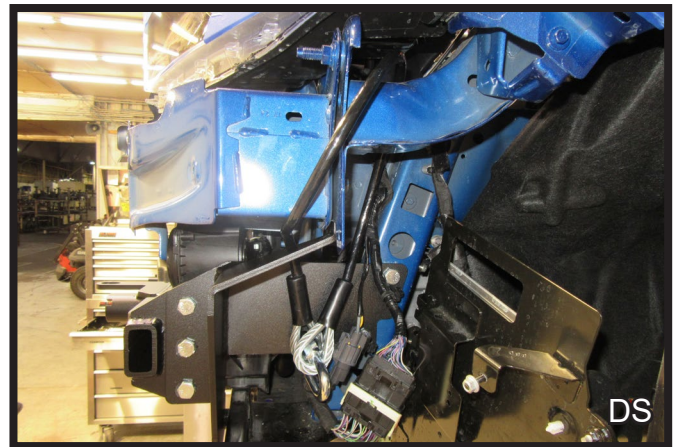
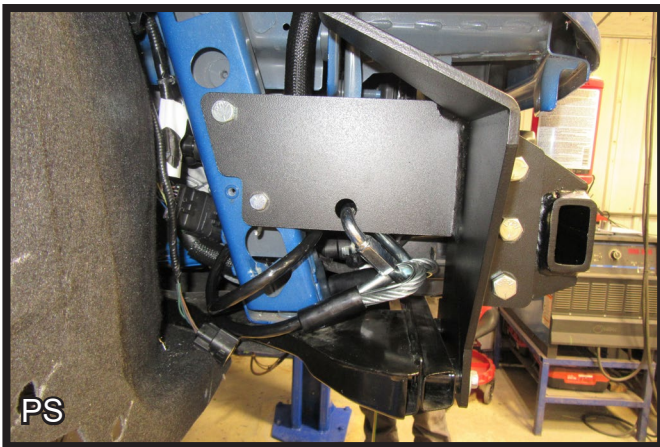

25. Attach the permanent baseplate safety cables to the provided convenience link on the baseplate. The photo above shows the recommended installation of the cables to frame of vehicle. Additional options may interfere with suggested mounting; in this case, secure the cables to a solid piece of the frame as described in the General Information sheet. Be sure the safety cables do not rub against any hoses or moving parts. Do this on **BOTH** sides of the vehicle.

BX2913  
2022-2024 Ford Maverick HEV  
(Includes Adaptive Cruise Control, Shutters & Hybrid)  
Installation Instructions

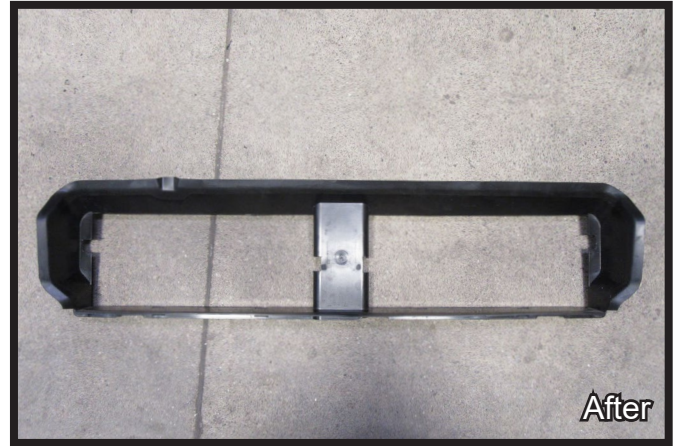
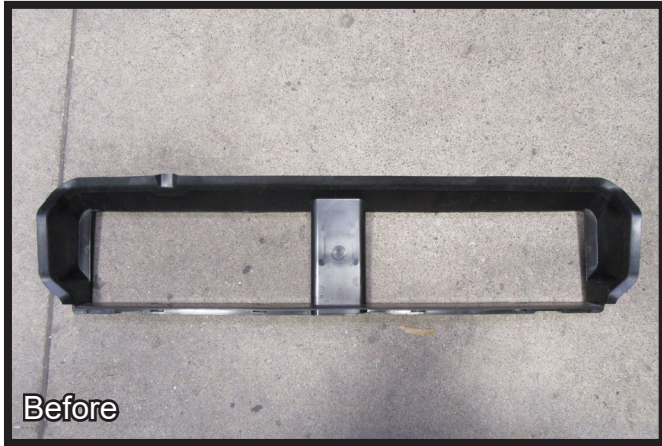

26. Using a reciprocating saw, notch the shutter shroud at each end and in the center as shown to allow for baseplate and electrical rod clearance. Reinstall shroud.



27. **Optional:** Install the breakaway switch to the breakaway bracket on the baseplate using the provided 1/4" bolt and nut.



28. Using a reciprocating saw, remove the two (2) vertical slats, one (1) on each side, between the white marks as shown to allow room for the removable tabs and convenience links.

BX2913  
2022-2024 Ford Maverick HEV  
(Includes Adaptive Cruise Control, Shuttters & Hybrid)  
Installation Instructions

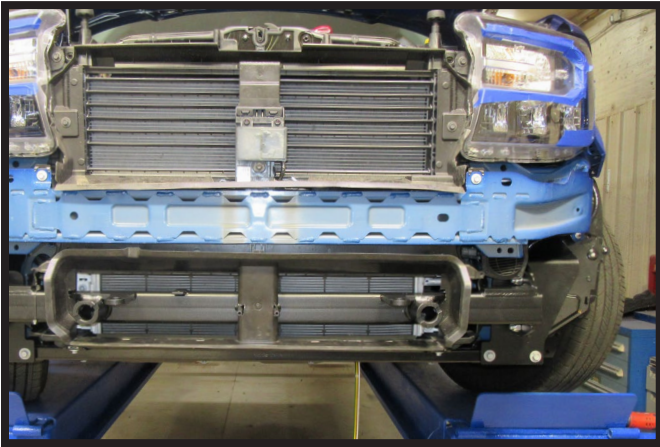

29. Reinstall the black box on the driver side of the vehicle. Reattach the wire loom to front of the box and to the bottom bolt on the backside. If the box touches the baseplate bolt head, bend back plate slightly to create clearance.



29. Reinstall the fascia and reconnect all electrical connections.

## CUSTOMER SERVICE COMMITMENT

Blue Ox® is committed to providing you with exceptional customer care throughout your lifetime with our products. Our team is here to assist you with any questions you may have regarding the performance of your product. Simply call (402) 385-3051 and you can speak with our customer service team.

Additionally, please visit our website to see which rallies our team will be attending. For a nominal fee, our service technician will service your towing system to ensure it's in proper working condition. Also, as a commitment to our customers, should you visit our factory, you can stay at our full service Blue Ox® campground at no charge along with enjoying a factory tour.

Again, thank you for being our customer and for the confidence you have shown in the performance of our products. It is because of customers like you we enjoy the success we have today.

© 2023 Blue Ox  
One Mill Road, Industrial Park  
Pender, Nebraska 68047  
Phone: (402) 385-3051  
Fax: (402) 385-3360  
[www.blueox.com](http://www.blueox.com)

# General Information

1. Ensure that your product(s) are registered online at [www.blueox.com](http://www.blueox.com). It is crucial to register your product(s) so that you may be alerted of product offerings, updates, upgrades, maintenance and safety bulletins, and/or recalls.
2. **It is the owner's responsibility to inspect all towing equipment for cracked welds, missing or worn parts and loose bolts before each towing trip.** Be sure to use Loctite® Red on all bolts and tighten to the recommended specifications.
3. **It is the owner's responsibility to hook up all towing equipment per manufacturer's instructions/recommendations.**
4. Remove the attachment tabs when not in use (if applicable).

## Notice To Baseplate Installer

### 1. It is YOUR responsibility to watch for:

- Oil cooler and air conditioner lines
- Electrical wires and hoses
- Missing parts or attaching points on the frame

\*\* If the baseplate is improperly installed and is against a wire or hose, it could cause fluid leaks or electrical shorts some time after the actual baseplate installation.

## Permanent Baseplate Safety Cable Installation

Permanent baseplate safety cables are strongly recommended when towing a vehicle with a tow bar. The principle function of the permanent baseplate safety cables is to prevent the towed vehicle from breaking loose in the event the connection between the frame of the towed vehicle and the baseplate fails or becomes disconnected. The cables must be connected from the baseplate to the frame rail or cross member of the vehicle's frame. The illustrations below show the possible arrangements recommended by Blue Ox®. Each permanent baseplate safety cable must have an adequate weight rating for the towing system. The weight rating of the two (2) cables together will not qualify.

***Do not mount the permanent baseplate safety cables against wires, hoses or brake lines.***

These permanent baseplate safety cables should remain installed as long as the baseplate is installed on the vehicle. Permanent baseplate safety cables are to be used in conjunction with, and NOT a replacement for legally required safety cables attaching the towed vehicle to the towing vehicle.

### Option #1

(Baseplates with Convenience Link Tabs)

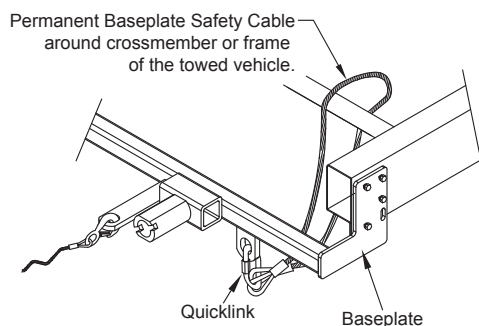

### Option #2

(Baseplates with out Convenience Link Tabs)

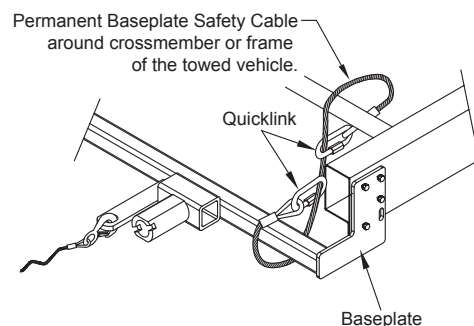

# BLUE OX ORIGINAL PURCHASERS THREE YEAR LIMITED WARRANTY

Automatic Equipment Manufacturing Company ("Automatic") warrants to the original (first) retail purchaser that this product, manufactured by Automatic, shall be free from defect in material and workmanship under normal use and service for a period of three years from the date of delivery.

During said three-year period, Automatic will repair or replace any parts that have been returned by the original purchaser, to the factory, transportation prepaid, and in Automatic's sole and absolute opinion found to be defective.

Limitations on Warranty Coverage:

Coverage under this warranty will be valid only if the customer warranty card is returned by the original purchaser within 30 days of purchase.

Coverage under this warranty will be effective only when a copy of the original invoice, showing date and place of purchase, accompanies any claim for warranty. This warranty is NON TRANSFERABLE.

This limited warranty will not cover, in any way or form, any alleged damages caused by incorrect or improper installation, improper use, modification or neglect of product, failure to properly service and maintain, misuse, act of God, accident or failure of the user to follow guidelines contained in the instructional material provided by Automatic.

This warranty does not cover normal wear and tear, paint or rust.

Warrantor assumes no responsibility to the owner for loss of use of product, loss of time, inconvenience or any other damage consequential or otherwise. Including, but not limited to mileage, expense of transporting of product, return shipping expense, mechanics travel time, telephone, road service, towing, and rental during repairs, travel, lodging, loss or damage to personal property or loss of earnings.

**REPAIR OR REPLACEMENT AS SET FORTH IN THIS LIMITED WARRANTY IS THE SOLE EXCLUSIVE REMEDY OF THE PURCHASER. AUTOMATIC SHALL NOT BE LIABLE FOR ANY INCIDENTAL OR CONSEQUENTIAL DAMAGES FOR BREACH OF ANY EXPRESS OR IMPLIED WARRANTY ON THIS PRODUCT. EXCEPT TO THE EXTENT PROHIBITED BY APPLICABLE LAW, ANY IMPLIED WARRANTY OF MERCHANTABILITY OR FITNESS FOR A PARTICULAR PURPOSE ON THIS PRODUCT IS LIMITED IN LENGTH TO THE DURATION OF THIS WARRANTY.**

Please visit <http://blueox.com/warranty/> to register your warranty



**BLUE OX**