



BXH2002

2020-2024 Buick Encore GX (No Hands Free Liftgate) 2021-2024 Chevy Trailblazer Installation Instructions

Please read the Installation Instructions prior to installing or operating this equipment.

1. Blue Ox® towing products and accessories are intended to be installed by Blue Ox® Dealers who are familiar with our products and have the equipment and knowledge necessary to do “fit work”. If needed, Blue Ox® Dealers can be found at www.blueox.com or by contacting our Customer Care Department at (402) 385-3051.
2. Many Blue Ox® receiver hitches are designed to use existing holes and hardware to mount the hitch to the vehicle. Even though bolts are there, do not assume they are adequate for receiver hitch mounting. Always use the hardware supplied in the hardware kit and existing hardware as specified in the installation instructions.

Serial Number

Bolt Torque Specifications

Torque in Foot-Pounds for Inch Bolts

Bolt Size	Grade 5	Grade 8
1/4"	10	14
5/16"	19	29
3/8"	33	47
7/16"	54	78
1/2"	78	119
5/8"	154	230
3/4"	257	380



If the rear of your vehicle looks different than this, please contact us at (402)385-3051.

Bolt Torque Specifications

Torque in Foot-Pounds for Metric Bolts

Bolt Size	Grade 8.8	Grade 10.9
6MM	6	8
8MM	16	22
10MM	31	40
12MM	54	70
14MM	89	117
16MM	161	230
18MM	222	318



WARNING

Failure to read and follow these instructions could result in separation of the towed item from the vehicle, causing property damage, loss of towed item, personal injury or death.



WARNING

Refer to your vehicle's owner's manual for maximum towing capacity. **DO NOT** exceed vehicle, pin or hitch weight ratings - failure to follow vehicle manufacturer's recommendations could result in damage to your vehicle, personal injury or death.

BXH2002
 2020-2024 Buick Encore GX (No Hands Free Liftgate)
 2021-2024 Chevy Trailblazer
 Installation Instructions

Hitch Type	Max Gross Trailer Weight (GTW)	Max Tongue Weight (TW)
Weight Carrying	3500 lb. (1589 kg)	350 lb. (159 kg)
Weight Distributing	DO NOT USE WITH	Spring Bars

Instruction Notes: The rear fascia and bumper are removed and reinstalled for the receiver hitch installation. Some trimming is required.

Place all components that are removed on a flat, sturdy surface. All items will be reinstalled unless otherwise noted after the receiver hitch is installed.

The dimensional variations between otherwise identical vehicles can be considerable. While the receiver hitch was designed for easy installation, it may be necessary to tailor the hitch slightly to compensate for vehicle manufacturer's tolerances.

NOTICE

- Handling of some cosmetic parts when installing this product may require the use of protective covers, rags, specialty tools, etc. to prevent damage.
- When using power drills be aware of the dangers of torque and drill bit length.
- When using a reciprocating saw be aware of objects behind the cutting surface.
- Use a good quality paint to spray cut edges of frame to prevent rusting.
- Be sure that **ALL** electrical connections are plugged in and accessories are functioning properly.
- The receiver hitch is tested to your vehicle's tow ratings, verify vehicle's tow rating because it may differ from receiver and use whichever is less. Exceeding this weight will void the manufacturer's warranty.
- Tighten all bolts according to the torque chart provided unless specified.
- Dealer or installer be certain the user receives these instruction sheets.
- If the receiver hitch is in an accident, it must be replaced. **DO NOT** use it again! An accident can cause unseen damage and using it again could result in more damage or serious injury. **DO NOT** use the hitch if it is damaged or missing parts.
- **DO NOT** alter this product in any way. Modifying this product could change the integrity and lead to a loss of connection between the towed item and the tow vehicle.
- The weight rating of the hitch assembly must be greater than the gross weight of the trailer.
- Without proper information, towing can be dangerous. Understand all risks involved with towing before starting. For more information on towing safety, see "**The Trailer Handbook: A Guide to Understand Trailer and Towing Safety**" from the *National Association of Trailer Manufacturers*, www.NATM.com.
- Check that all bolted connections are at the correct torque specification on a regular basis. Complete a visual inspection before towing each time.
- Ensure that installation is performed by someone who is aware of the risks and has knowledge of hazards and proper safety procedures involved with adding components to the chassis of a vehicle and the tools needed for installation.

BXH2002
 2020-2024 Buick Encore GX (No Hands Free Liftgate)
 2021-2024 Chevy Trailblazer
 Installation Instructions

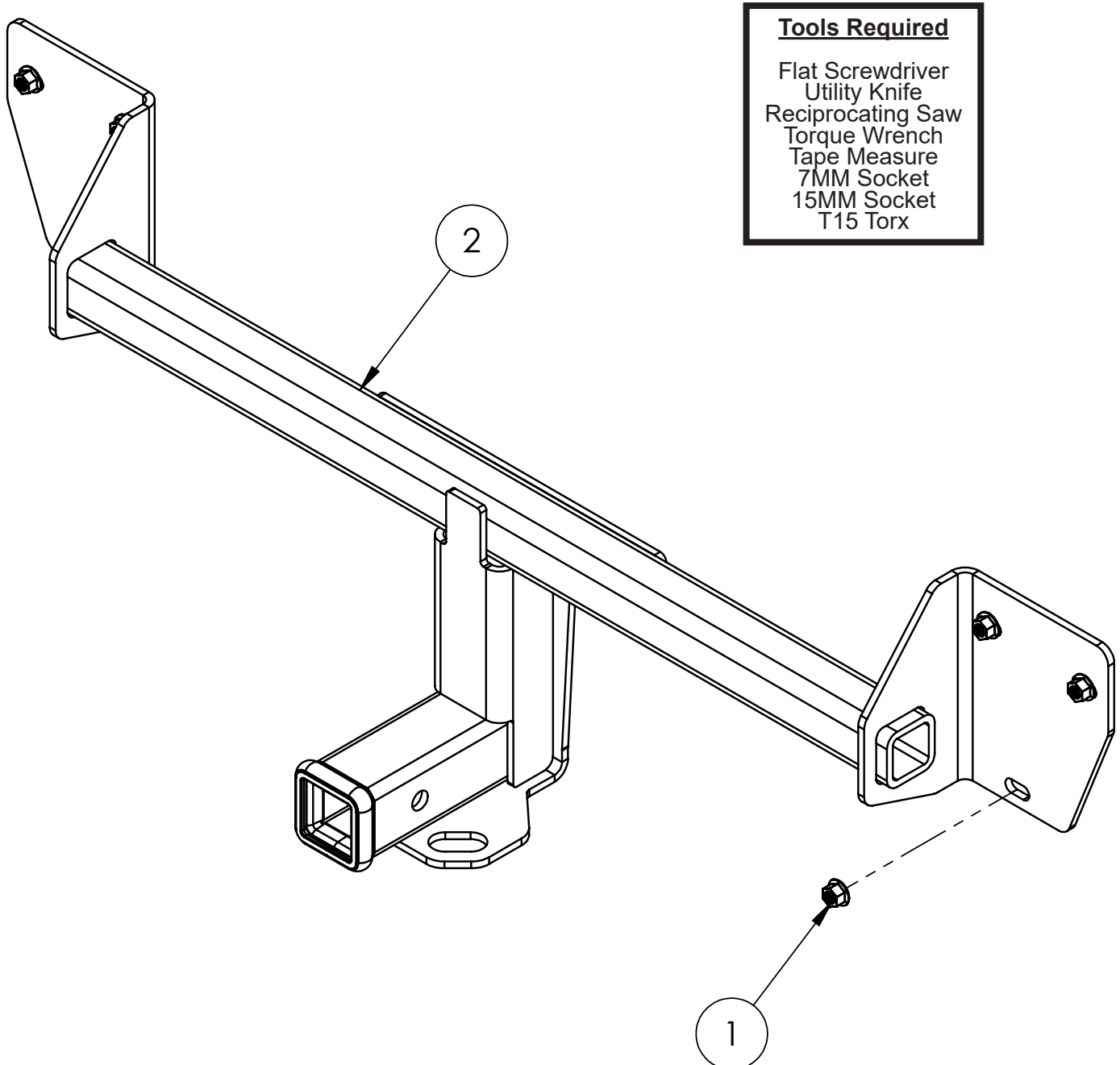

- | Tools Required | |
|-------------------|--|
| Flat Screwdriver | |
| Utility Knife | |
| Reciprocating Saw | |
| Torque Wrench | |
| Tape Measure | |
| 7MM Socket | |
| 15MM Socket | |
| T15 Torx | |

Item No.	Part No.	Description	Qty.
1.....	Existing.....	M10 x 1.25MM Flanged Hex Nut.....	6
2.....	61-8721	Receiver Hitch, 2"	1
3.....	63-5047(not shown)	Bolt Bag and Manual Package	1

Important:

Use only genuine factory replacement parts on your hitch receiver. Do **NOT** substitute homemade or non-typical parts. If a bolt is lost or in need of replacement, for your safety and the preservation of your hitch receiver, be sure to use a replacement bolt of the same grade (In most cases it will be Grade 8, please reference the parts list above). Replacement parts may be ordered through your nearest Blue Ox® Dealer or Distributor. Failing to follow and/or altering these installation instructions in either installation or required equipment will void the manufacturer's warranty.

BXH2002
2020-2024 Buick Encore GX (No Hands Free Liftgate)
2021-2024 Chevy Trailblazer
Installation Instructions



1. Remove the two (2) plastic caps next to the tail light. Do this on both sides of the vehicle.



2. Using a T15 Torx, remove the two (2) bolts next to the tail light. Do this on both sides of the vehicle.



3. Push tailing toward the rear, remove and let hang. Do this on both sides of the vehicle.



4. Using a T15 Torx, remove the two (2) bolts from the below the trail light housing. There is one (1) on each side of the vehicle.

BXH2002
2020-2024 Buick Encore GX (No Hands Free Liftgate)
2021-2024 Chevy Trailblazer
Installation Instructions

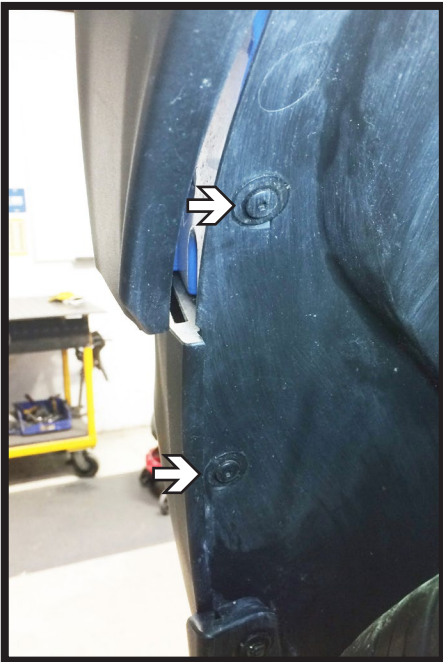

5. Using a T15 Torx, remove the two (2) bolts from the edge of the wheel well. Do this on both sides of the vehicle.



6. Using a T15 Torx, remove the three (3) bolts from the rear mud flap. Do this on both sides of the vehicle.



7. Using a 7MM socket, remove the one (1) bolt underneath the mud flap. Do this on both sides of the vehicle.



8. Pull back the rear wheel well trim past the fascia joint. Prop trim away from the vehicle using a soft cloth. Do this on both sides of the vehicle.

BXH2002
2020-2024 Buick Encore GX (No Hands Free Liftgate)
2021-2024 Chevy Trailblazer
Installation Instructions

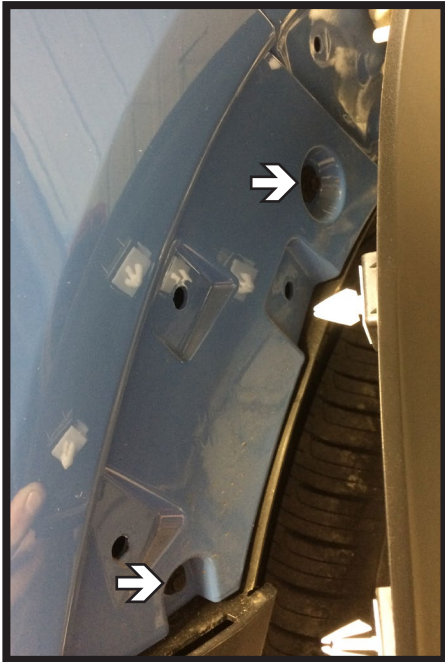

9. Using a 7MM socket, remove the two (2) bolts. Do this on both sides of the vehicle.

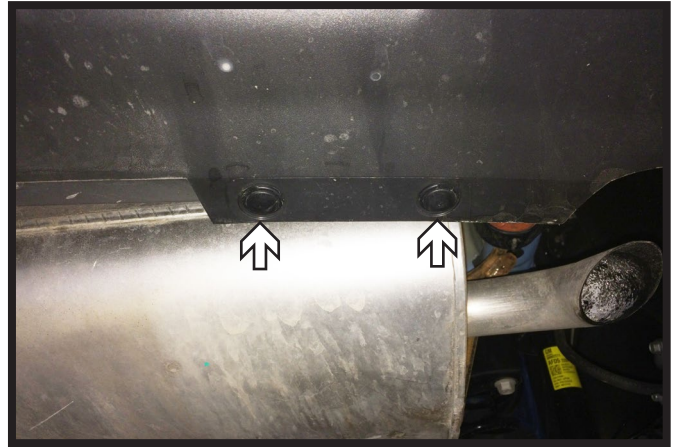

10. Remove the two (2) push pins from the underside of the vehicle. Do this on both sides of the vehicle.



11. Using a T15 Torx, loosen the one (1) bolt behind the tire and rotate outward. Do this on both sides of the vehicle.

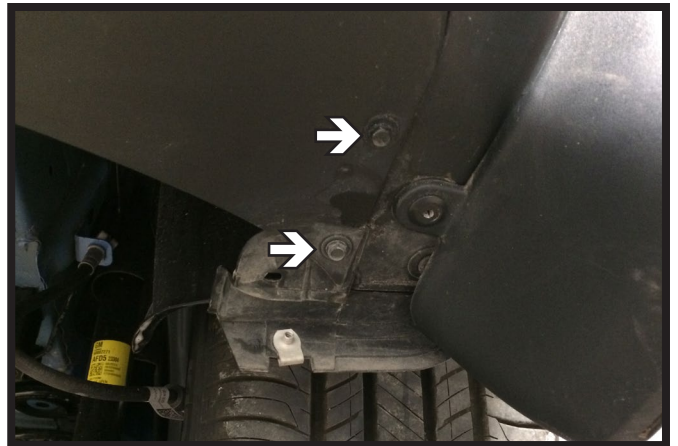

12. Using a 7MM socket, remove the two (2) bolts from behind the tire. Do this on both sides of the vehicle.

BXH2002
2020-2024 Buick Encore GX (No Hands Free Liftgate)
2021-2024 Chevy Trailblazer
Installation Instructions



13. Using a T15 Torx, remove the one (1) bolt from behind the tire. Do this on both sides of the vehicle.

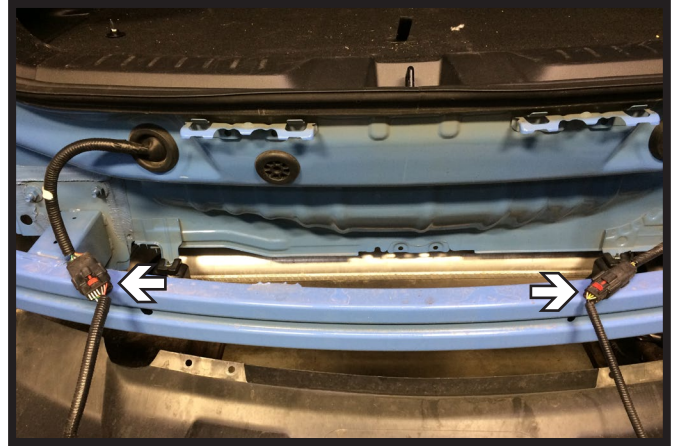

14. As the rear fascia is removed, unplug the two (2) electrical connections. There is one (1) on each side of the vehicle. Remove the fascia and set aside to be reinstalled later.



15. Using a utility knife or razor blade, cut around the bumper where it attaches to the frame.

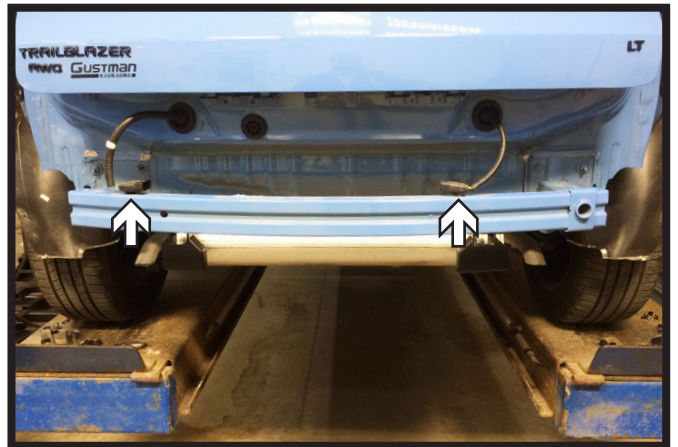

16. Unclip the wire loom from the bumper on each side of the vehicle.

BXH2002
2020-2024 Buick Encore GX (No Hands Free Liftgate)
2021-2024 Chevy Trailblazer
Installation Instructions

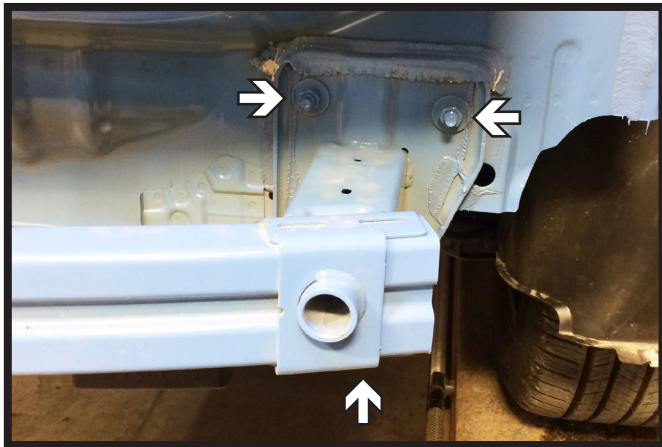

17. Using a 15MM socket, remove the three (3) nuts from the rear bumper. Do this on both sides of the vehicle. Remove bumper and set aside to be reinstalled later.

Note: If needed use a flat screw driver to pry the bumper away from the frame.

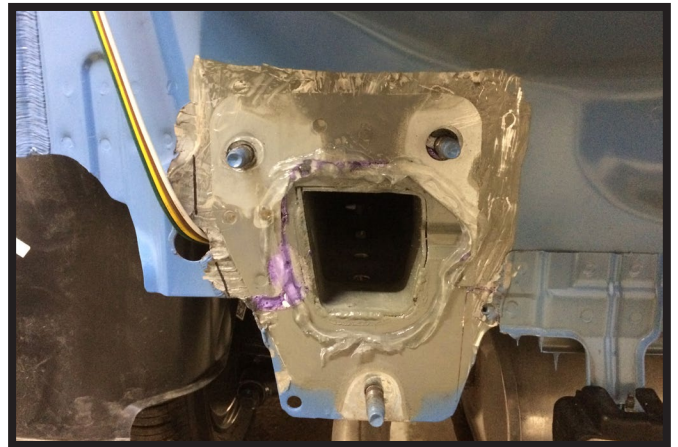

18. Apply clear 100% silicone around the frame hole as shown. Do this on both sides of the vehicle.

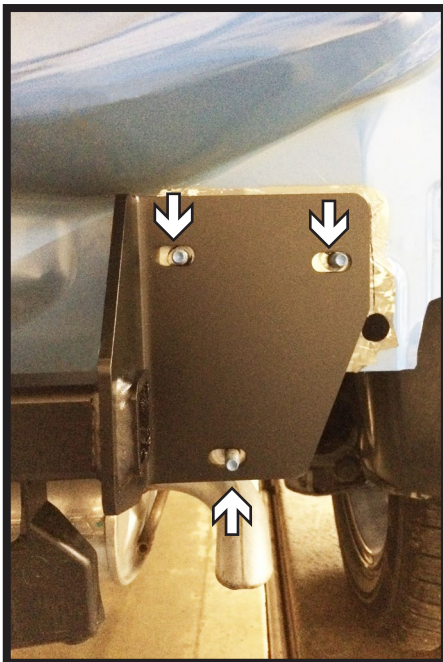

19. Slide the receiver onto the vehicle. Apply clear 100% silicone around the three (3) bolt holes of the receiver. Do this on both sides of the vehicle.

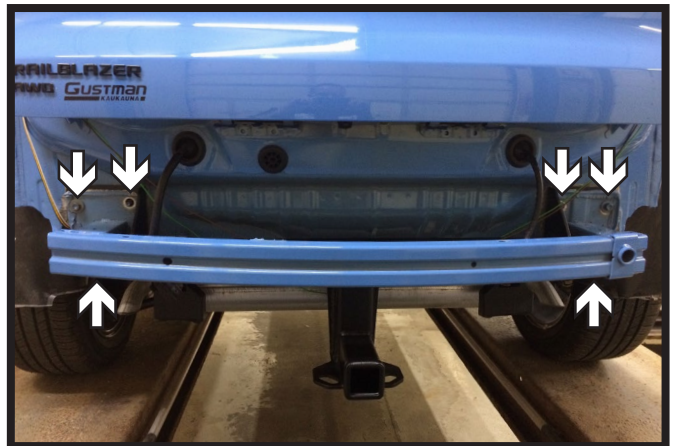

20. Place the rear bumper onto the vehicle. Reinstall the six (6) existing nuts and tighten.

**** Tighten all bolts to 31 ft/lbs. ****

BXH2002
2020-2024 Buick Encore GX (No Hands Free Liftgate)
2021-2024 Chevy Trailblazer
Installation Instructions

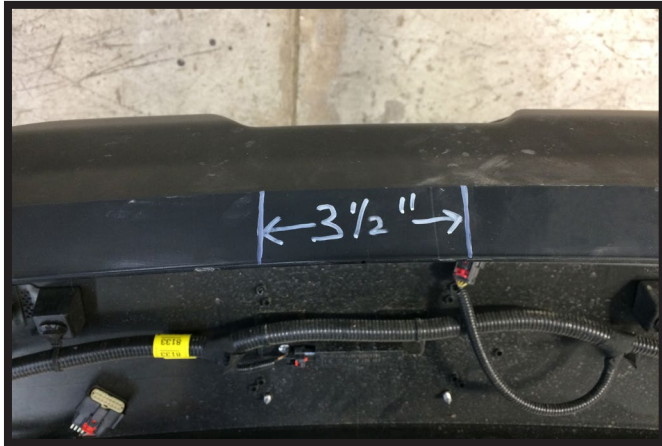

25. Using a reciprocating saw trim the rear fascia to allow clearance for the receiver hitch. Approximately 3-1/2" wide by 2" deep.



26. Reinstall the rear fascia and reconnect all electrical connections.

CUSTOMER SERVICE COMMITMENT

Blue Ox® is committed to providing you with exceptional customer care throughout your lifetime with our products. Our team is here to assist you with any questions you may have regarding the performance of your product. Simply call (402) 385-3051 and you can speak with our customer service team.

Additionally, please visit our website to see which rallies our team will be attending. For a nominal fee, our service technician will service your towing system to ensure it's in proper working condition. Also, as a commitment to our customers, should you visit our factory, you can stay at our full service Blue Ox® campground at no charge along with enjoying a factory tour.

Again, thank you for being our customer and for the confidence you have shown in the performance of our products. It is because of customers like you we enjoy the success we have today.

© 2023 Blue Ox
One Mill Road, Industrial Park
Pender, Nebraska 68047
Phone: (402) 385-3051
Fax: (402) 385-3360
www.blueox.com

General Information

1. Ensure that your product(s) are registered online at www.blueox.com. It is crucial to register your product(s) so that you may be alerted of product offerings, updates, upgrades, maintenance and safety bulletins, and/or recalls.
2. **It is the owner's responsibility to inspect all towing equipment for cracked welds, missing or worn parts and loose bolts before each towing trip.** Be sure to tighten all bolts to the recommended specifications.
3. **It is the owner's responsibility to hook up all towing equipment per manufacturer's instructions/recommendations.**

Notice To Receiver Hitch Installer

1. **It is YOUR responsibility to watch for:**

- Electrical wires and hoses
- Missing parts or attaching points on the frame

** If the hitch receiver is improperly installed and is against a wire or hose, it could cause fluid leaks or electrical shorts some time after the actual hitch installation.

BLUE OX ORIGINAL PURCHASERS LIMITED LIFETIME WARRANTY

Automatic Equipment Manufacturing Company ("Automatic") warrants to the original (first) retail purchaser that this product, manufactured by Automatic, shall be free from defect in material and workmanship under normal use and service for as long as the original retail purchaser owns the product.

During said period, Automatic will repair or replace any parts that have been returned by the original purchaser, to the factory, transportation prepaid, and in Automatic's sole and absolute opinion found to be defective.

Limitations on Warranty Coverage:

Coverage under this warranty will be valid only if the customer warranty card is returned by the original purchaser within 30 days of purchase.

Coverage under this warranty will be effective only when a copy of the original invoice, showing date and place of purchase, accompanies any claim for warranty. This warranty is NON TRANSFERABLE.

This limited warranty will not cover, in any way or form, any alleged damages caused by incorrect or improper installation, improper use, modification or neglect of product, failure to properly service and maintain, misuse, act of God, accident or failure of the user to follow guidelines contained in the instructional material provided by Automatic.

This warranty does not cover normal wear and tear, paint or rust.

Warrantor assumes no responsibility to the owner for loss of use of product, loss of time, inconvenience or any other damage consequential or otherwise. Including, but not limited to mileage, expense of transporting of product, return shipping expense, mechanics travel time, telephone, road service, towing, and rental during repairs, travel, lodging, loss or damage to personal property or loss of earnings.

REPAIR OR REPLACEMENT AS SET FORTH IN THIS LIMITED WARRANTY IS THE SOLE EXCLUSIVE REMEDY OF THE PURCHASER. AUTOMATIC SHALL NOT BE LIABLE FOR ANY INCIDENTAL OR CONSEQUENTIAL DAMAGES FOR BREACH OF ANY EXPRESS OR IMPLIED WARRANTY ON THIS PRODUCT. EXCEPT TO THE EXTENT PROHIBITED BY APPLICABLE LAW, ANY IMPLIED WARRANTY OF MERCHANTABILITY OR FITNESS FOR A PARTICULAR PURPOSE ON THIS PRODUCT IS LIMITED IN LENGTH TO THE DURATION OF THIS WARRANTY.

Please visit <http://blueox.com/warranty/> to register your warranty



BLUE OX