



# BX1987

## 2008-2015 Smart Car Installation Instructions

**Attachment Tab Height: 13-1/2"**

**Attachment Tab Width: 17"**

**Serial Number**

**Please read BOTH these Installation Instructions and the General Instructions prior to installing or operating this equipment.**

1. Blue Ox® towing products and accessories are intended to be installed by Blue Ox® Dealers who are familiar with our products and have the equipment and knowledge necessary to do "fit work". If needed, Blue Ox® Dealers can be found at [www.blueox.com](http://www.blueox.com) or by contacting our Customer Care Department at (402) 385-3051.
2. Many Blue Ox® baseplates are designed to use existing holes and hardware to mount the baseplate to the towed vehicle. Even though bolts are there, do not assume they are adequate for baseplate mounting. Always use the hardware supplied in the hardware kit and existing hardware as specified in the installation instructions.

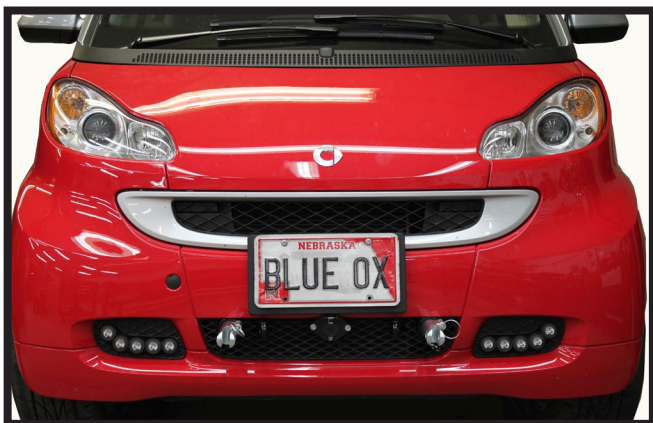

If the front of your vehicle looks different than this, please contact us at (402)385-3051.

**Reference your vehicle owner's manual for manufacturer's towing specifications.**

### Bolt Torque Specifications

Torque in Foot-Pounds for Inch Bolts

Bolt Size	Grade 5	Grade 8
1/4"	10	14
5/16"	19	29
3/8"	33	47
7/16"	54	78
1/2"	78	119
5/8"	154	230
3/4"	257	380

### Bolt Torque Specifications

Torque in Foot-Pounds for Metric Bolts

Bolt Size	Grade 8.8	Grade 10.9
6MM	6	8
8MM	16	22
10MM	31	40
12MM	54	70
14MM	89	117
16MM	161	230
18MM	222	318



## WARNING

Failure to read and follow these instructions could result in separation of the towed vehicle from the tow bar, causing property damage, loss of towed vehicle, personal injury or death.

BX1987  
2008-2015 Smart Car  
Installation Instructions

**Instruction Notes:** The hood, antenna, fascia, tires and bumper are removed and reinstalled for the baseplate installation. Some drilling and trimming is required.

Place all components that are removed on a flat, sturdy surface. All items will be reinstalled unless otherwise noted after the baseplate is installed.

The dimensional variations between otherwise identical vehicles can be considerable. While the baseplate was designed for easy installation, it may be necessary to tailor the baseplate slightly to compensate for vehicle manufacturer's tolerances.

The BX8848 4-Diode Wiring Kit is recommended for this vehicle.

*Due to the narrow wheel base of the Smart Car there is a problem with the steering coming back to a straight position after making a turn. Bungee cords can be used to straighten the wheel back out. Place two bungee cords crossing from one side of the steering wheel to the other side of the driver seat, this gives resistance in each direction to bring the steering wheel back to center after making a turn.*

## **NOTICE**

- Handling of some cosmetic parts when installing this product may require the use of protective covers, rags, specialty tools, etc. to prevent damage.
- When using power drills be aware of the dangers of torque and drill bit length.
- When using a reciprocating saw be aware of objects behind the cutting surface.
- Use a good quality paint to spray cut edges of frame to prevent rusting.
- Be sure that **ALL** electrical connections are plugged in and accessories are functioning properly before reinstalling the fascia.
- The baseplate is computer tested to your vehicle's GVWR, exceeding this weight will void the manufacturer's warranty.
- Be sure to use a sufficient amount of Loctite® Red on all bolt threads before tightening. Tighten all bolts according to the torque chart provided unless specified.
- Dealer or installer be certain the user receives these instruction sheets.
- If the baseplate is in an accident, it must be replaced. **DO NOT** use it again! An accident can cause unseen damage and using it again could result in more damage or serious injury. **DO NOT** use the baseplate if it is damaged or missing parts.

# BX1987 2008-2015 Smart Car Installation Instructions

## Tools Required

Large Vise Grip  
 Flat Screwdriver  
 Utility Knife  
 Phillips Screwdriver  
 Torque Wrench  
 Drill  
 Tape Measure  
 Loctite® RED  
 13/32" Drill Bit  
 10MM Socket  
 15MM Socket  
 9/16" Socket  
 9/16" Wrench  
 3/8" 12 Point Socket  
 5/16" 12 Point Socket  
 T25 Torx  
 T30 Torx

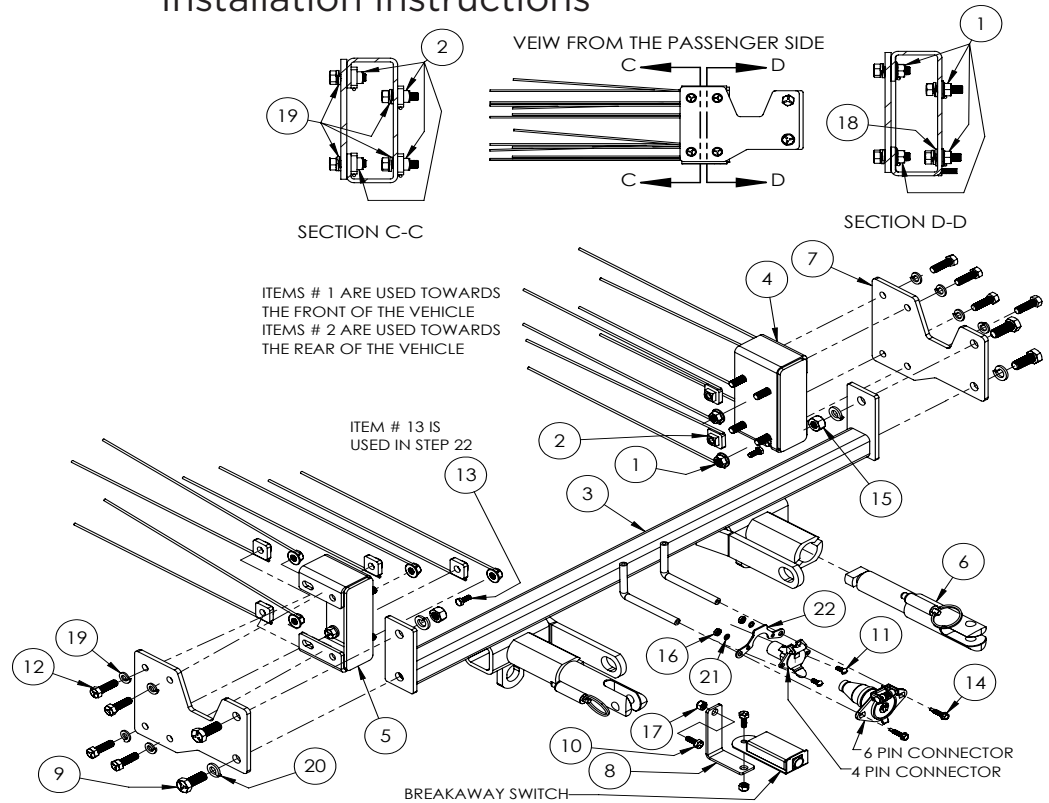

Item No.	Part No.	Description	Qty.
1	61-4978	3/8"-16 Whiz Nut w/ 14" Wire	8
2	61-5208	3/8"-16 Nut Plate w/ 14" Wire	8
3	61-6507	BX1987 Baseplate	1
4	61-6508	Driver Side Support Bracket	1
5	61-6509	Passenger Side Support Bracket	1
6	62-3469	Attachment Tab	2
7	101-7196	BX1987 Endplate	2
8	102-7287	Breakaway Bracket	1
9	201-0011	1/2"-13 x 1-1/4" Hex Head Bolt, Grade 5, ZP	4
10	201-0050	1/4"-20 x 3/4" Hex Head Bolt, Grade 5, ZP	2
11	201-0192	#10-32 x 1/2" Slotted Round Head Screw	2
12	201-0368	3/8"-16 x 1-1/4" Head Head Bolt, Grade 5, ZP	16
13	201-0461	6MM-1.0 x 15MM Hex Head Bolt, Grade 8.8	2
14	201-0979	#12-14 x 1" Self Drilling Screw, ZP	2
15	202-0005	1/2"-13 Hex Nut, ZP	2
16	202-0047	#10-32 Hex Nut	2
17	202-0102	1/4"-20 Hex Nylon Nut, ZP	2
18	203-0003	3/8" Flat Washer, ZP	2
19	203-0010	3/8" Lock Washer, ZP	16
20	203-0012	1/2" Lock Washer, ZP	4
21	203-0054	#10 Lock Washer	2
22	299-0685	Electrical Bracket, Zp	1
23 (not shown)	226-0046	36" Class III Baseplate Safety Cable	2
24 (not shown)	229-0359	3/8" Quicklink, ZP	2
25 (not shown)	290-0437	Black Cap Plug Receiver	2

## Important:

Use only genuine factory replacement parts on your baseplate. Do **NOT** substitute homemade or non-typical parts. If a bolt is lost or in need of replacement, for your safety and the preservation of your baseplate, be sure to use a replacement bolt of the same grade (In most cases it will be Grade 5, please reference the parts list above). Replacement parts may be ordered through your nearest Blue Ox® Dealer or Distributor. Failing to follow and/or altering these installation instructions in either installation or required equipment will void the manufacturer's warranty. Towing behind a non-motorized vehicle will void the warranty.

BX1987  
2008-2015 Smart Car  
Installation Instructions



1. Pull the lever in the front to the outside. Do this on both sides of the vehicle. Lift the hood off and set aside.

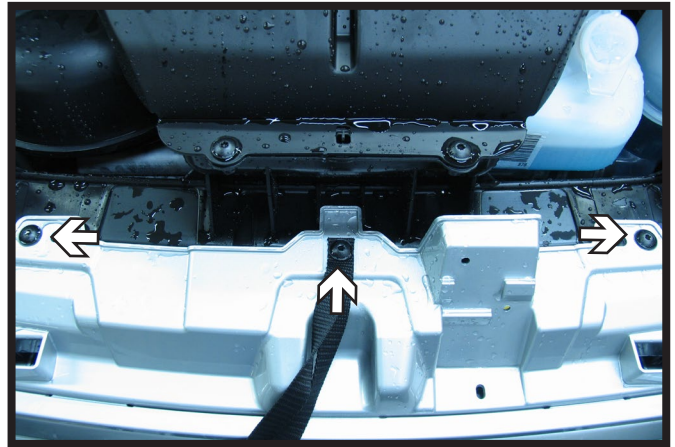

2. Using a T25 Torx, remove the three (3) screws from the top edge of the fascia.

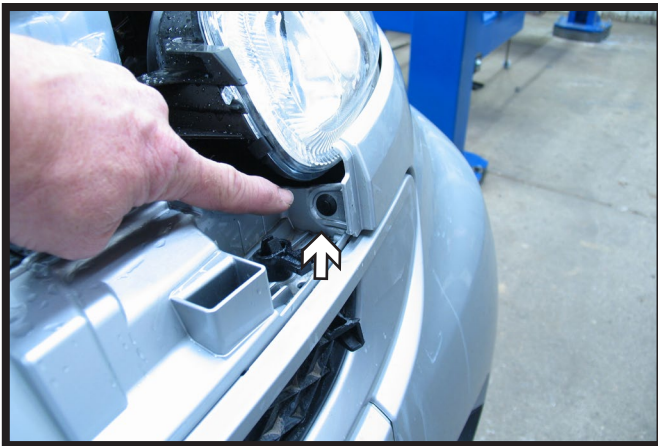

3. Remove the push pin just below the head light. Do this on both sides of the vehicle.



4. Using the 25 Torx, remove the bolt above the headlight. Do this to both sides of the vehicle.

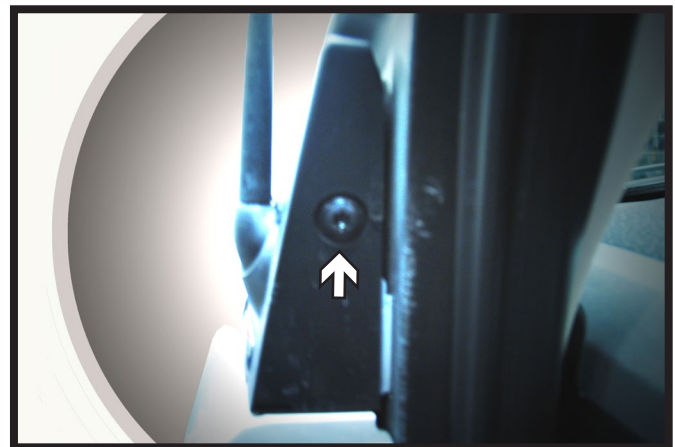

5. Open the door, inside next to the antenna, remove the bolt with a 30 Torx. Do this on both sides of the vehicle.

BX1987  
2008-2015 Smart Car  
Installation Instructions

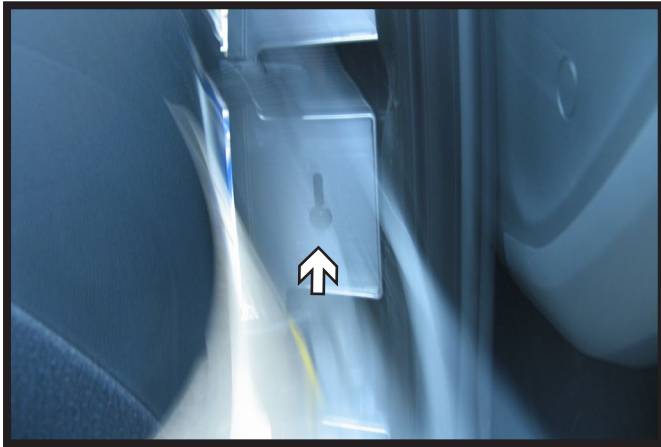

6. Lower on the inside of the door, remove the push pin. Do this on both sides of the vehicle.



7. Unscrew the antenna in order to be able to remove the fascia. Also, remove the outer cover by gently pulling on it.

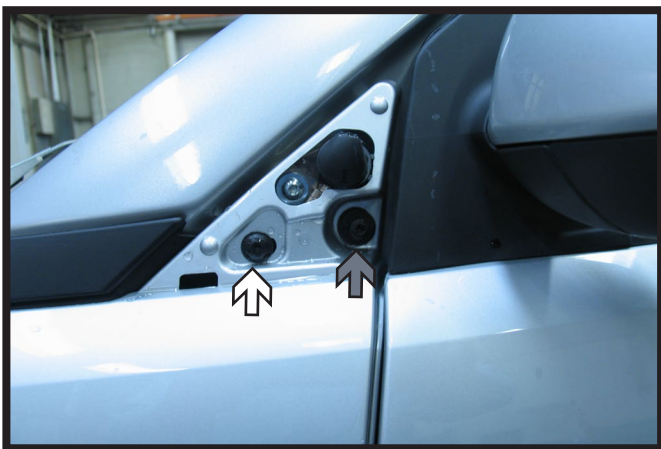

8. Using the 25 Torx, remove the front bolt next to the antenna (white). Then remove the rear bolt using a 30 Torx (gray).



9. In front of the back tire, remove two (2) push pins. Do this on both sides of the vehicle.



10. Using a flat screwdriver, pry the black covering piece off of each of the five (5) tabs below the door panel. Do this on both sides of the vehicle.

BX1987  
2008-2015 Smart Car  
Installation Instructions



11. Using the 25 Torx, remove the bolt holding the fascia just behind the front tire. Do this on both sides of the vehicle.

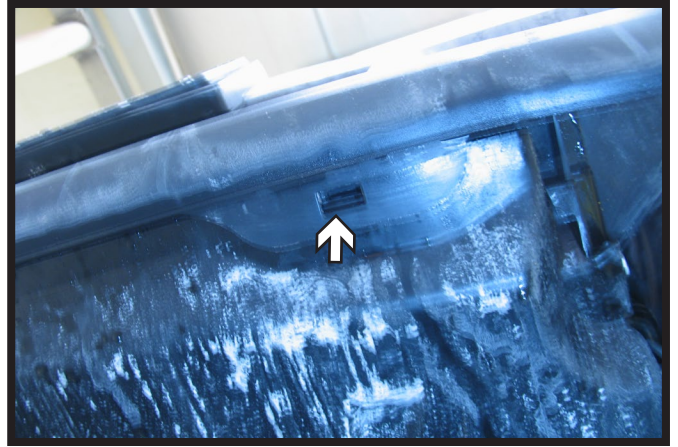

12. Underneath in the front, pop the fascia out of the two (2) clips. Pull fascia corner out to the side of vehicle, both sides, then pull fascia forward and set aside carefully.



13. Put the vehicle up on jack stands, use a 15MM socket to remove the tire lug nuts. Take the tire off. Do this on both sides of the vehicle.

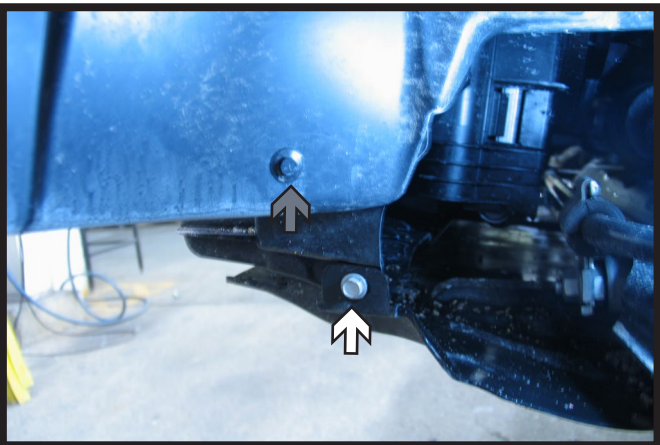

14. Using a 10MM socket, remove the bolt on the wheel well at the front. Remove the push pin above, (gray). Do this on both sides of the vehicle.



15. Remove push pin from the top of the wheel well. Do this on both sides of the vehicle.

**NOTE: This step is not necessary on 2012 models.**

BX1987  
2008-2015 Smart Car  
Installation Instructions

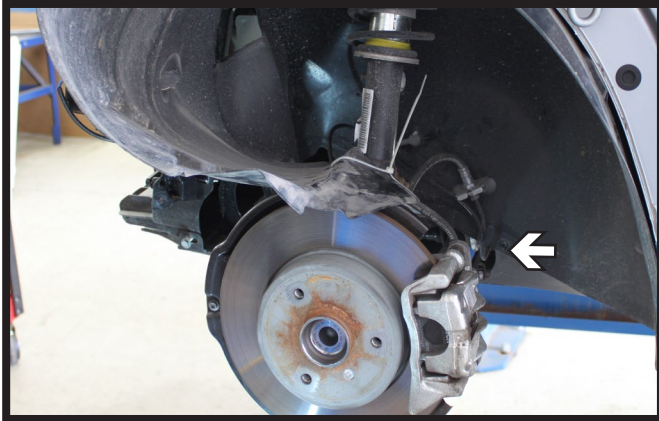

16. Using a 10MM socket, remove the bolt on the bottom. Do this on both sides of the vehicle.

**NOTE: This step is not necessary on 2012 models.**



17. Remove the push pin on the right side. Do this on both sides of the vehicle. Pull the wheel well covers out of the way.

**NOTE: This step is not necessary on 2012 models.**

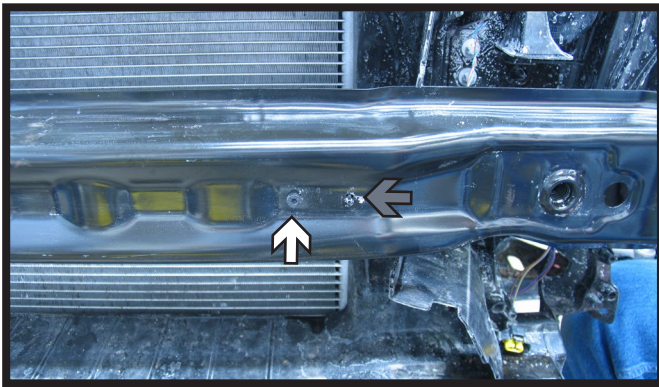

18. Using the 25 Torx, remove the bolt from the air temperature sensor on the back side of the metal bumper. Also, remove the push pin beside it (gray). Do this on both sides of the vehicle.

**NOTE: This step is not necessary on 2012 models.**

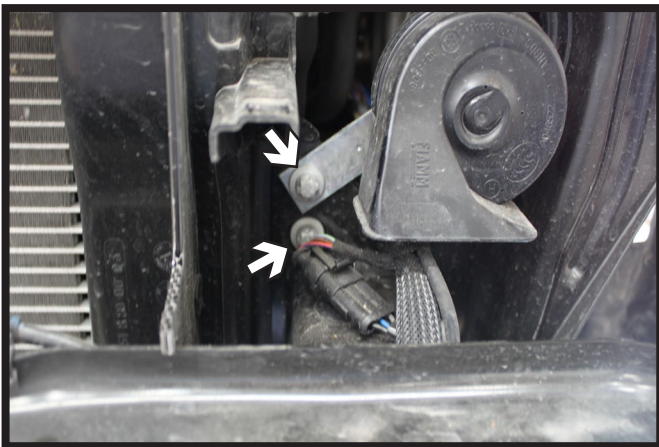

19. Using the 3/8" 12 point socket, remove the four (4) bolts holding the bumper. Do this on both sides of the vehicle. Set the bumper aside.

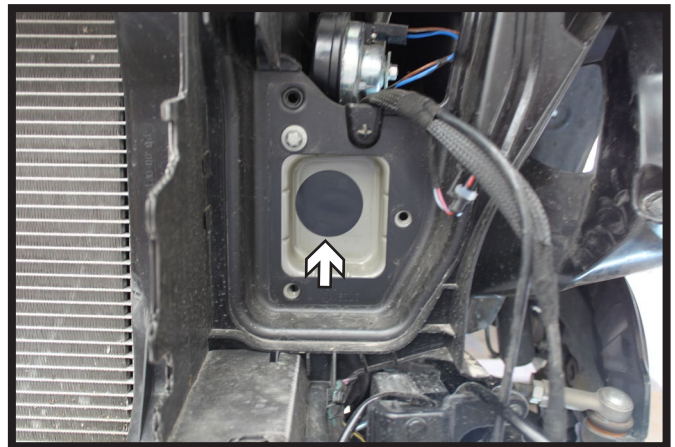

20. Peel off the tape covering the frame hole to allow nut plate access for baseplate installation. Do this on both sides of the vehicle.

BX1987  
2008-2015 Smart Car  
Installation Instructions

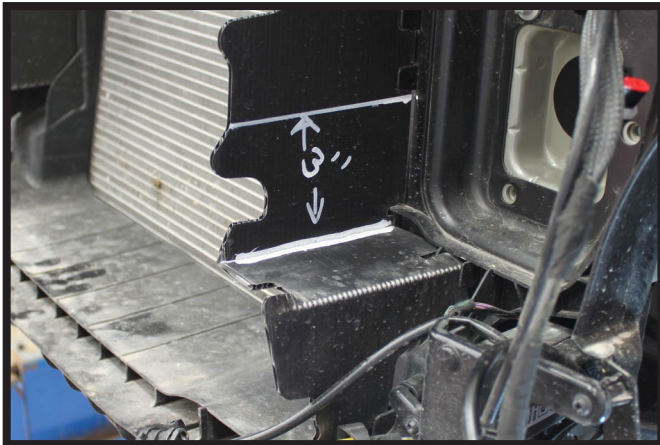

21. Using the utility knife, cut a piece 3" wide from the middle of the corrugated plastic. This will allow the baseplate to slide on.

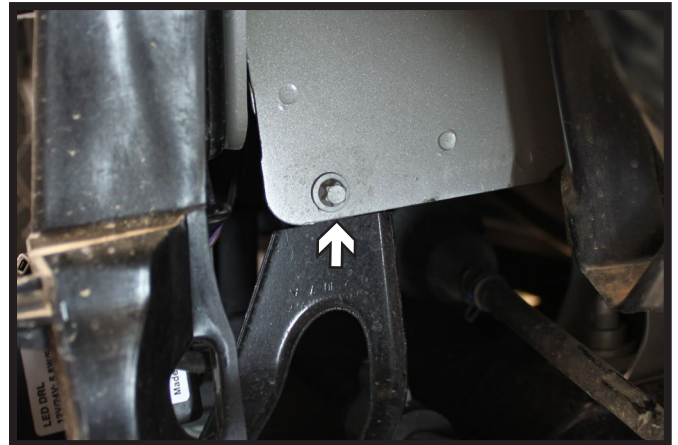

22. **2012-15 models only:** Using a 5/16" 12 point socket remove the bolt on both sides of the vehicle. Replace with the 6MM-1.0 x 16MM bolts that are included in the baseplate bolt bag. Be sure the sides of the bolt head are vertical so the bracket will slide on easily.

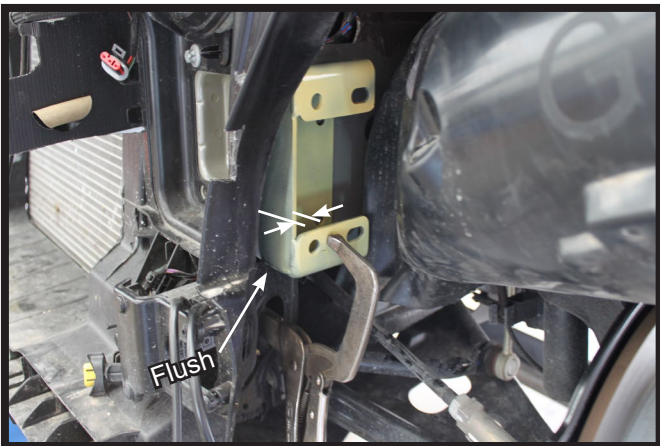

23. Align the support bracket, 1/4" from the backside of the bumper lip and flush with the bottom of the frame and clamp into position. Do this on both sides of the vehicle.

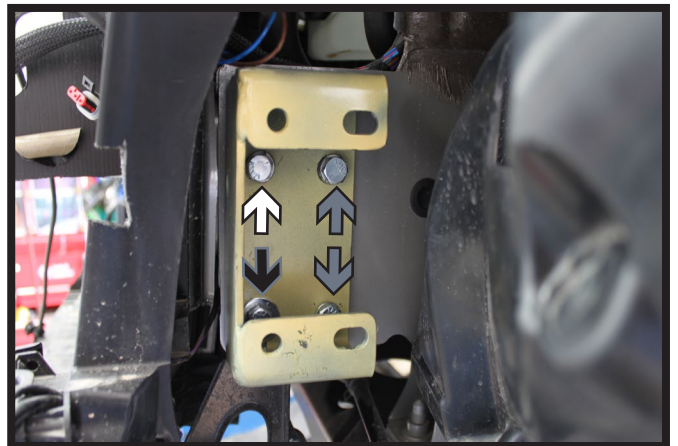

24. Using the support bracket holes as a template, drill four (4) holes thru the frame with a 13/32" drill bit. Use two (2) 3/8"-16 x 1-1/4" bolts with 3/8" lock washers and 3/8"-16 nut plates in the rear holes (gray). Use a 3/8"-16 x 1-1/4" bolt with 3/8" lock washer and 3/8"-16 whiz nut in top front hole (white). Use a 3/8"-16 x 1-1/4" bolt with 3/8" lock washer, 3/8" flat washer and 3/8"-16 whiz nut in bottom front hole (black). Do this to both sides of the vehicle.



BX1987  
2008-2015 Smart Car  
Installation Instructions

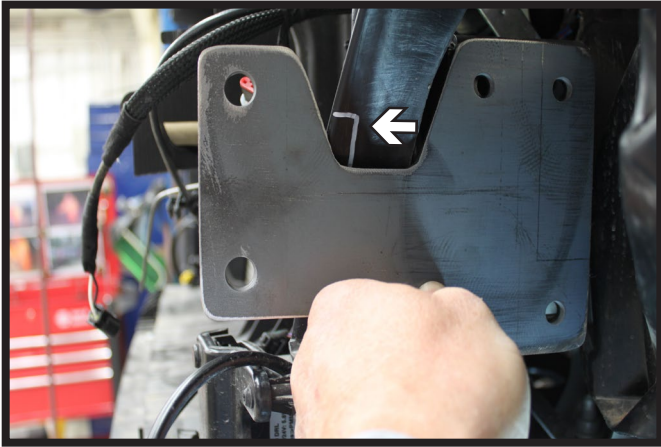

25. Line up the bolt holes of the support bracket and side plate by hand and mark a notch. This notch needs to provide enough clearance to allow the side plate to be installed.

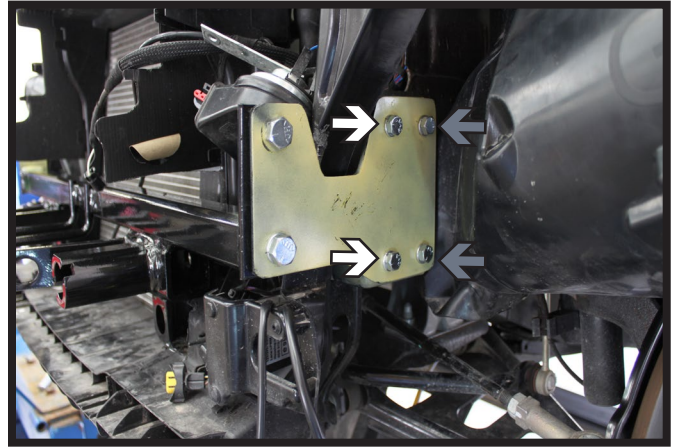

26. Loosely attach the support bracket to the end plate. Use 3/8"-16 x 1-1/4" bolts with 3/8" lock washers (gray) and 3/8"-16 nut plates. On the front holes, use 3/8"-16 x 1-1/4" bolts with 3/8" lock washers and 3/8" whiz nuts. Do this to both sides of the vehicle.

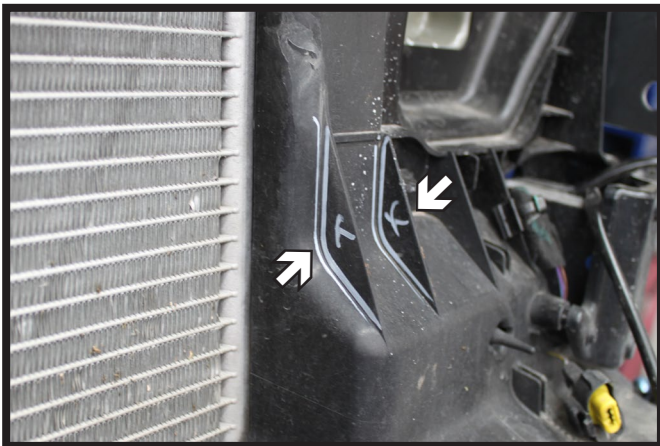

27. On the driver side of the vehicle, use a utility knife to remove the two (2) gussets.



28. On the passenger side, trim off the tab using the outer edge as a guide.

BX1987  
2008-2015 Smart Car  
Installation Instructions

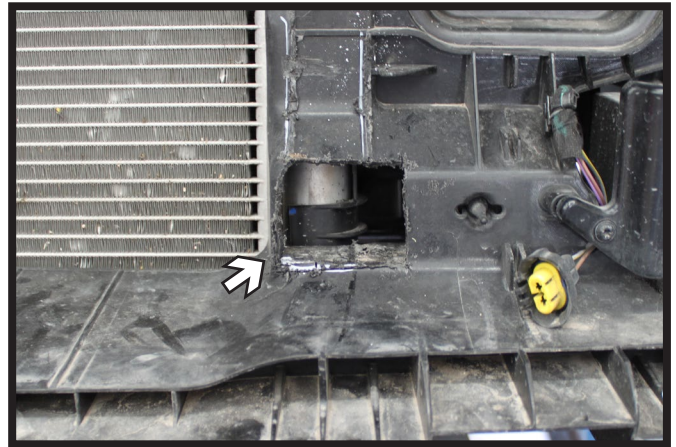
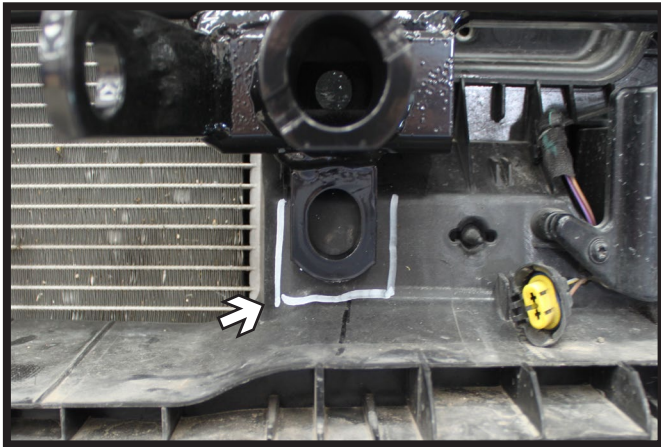

29. Trimming of the air dam is required for the placement of the permanent baseplate safety cables. Loosely attach the baseplate at the upper front bolt location. Mark the area on the air dam just behind the convenience link (left). Remove the baseplate and cut a hole in the air dam to allow the connection of cables/quicklinks to baseplate (right). **Be aware of radiator condenser and other related items behind the plastic.**



30. **2014 & up Models w/Fog Lights Only:**  
Trim the top of the fog light bezels on both sides of the vehicle as shown for baseplate clearance.

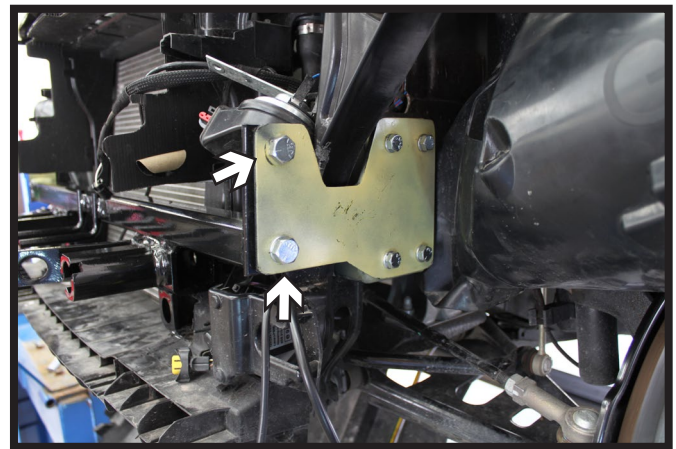

31. Fasten the baseplate to the brackets, using 1/2"-13 x 1-1/4" bolts with 1/2" lock washers. The top hole requires a 1/2" hex nut and the bottom hole the bolt will thread into the baseplate tube. Do this on both sides of the vehicle. Fully tighten all baseplate fasteners.

BX1987  
2008-2015 Smart Car  
Installation Instructions

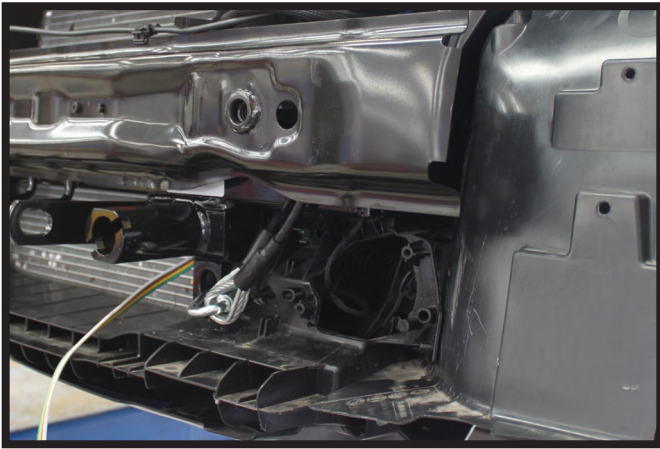

32. Attach the permanent baseplate safety cables to the provided convenience link on the baseplate. The photo above shows the recommended installation of the cables to frame of vehicle. Additional options may interfere with suggested mounting; in this case, secure the cables to a solid piece of the frame as described in the instructions included with the permanent baseplate safety cables. Be sure the safety cables do not rub against any hoses or moving parts. Do this on **BOTH** sides of the vehicle.



33. Trim the lower portion of the inner wheel well as shown to allow the wheel well to be reinstalled to its original position.



34. Hold the fascia as close to its original position, mark and trim the fascia around the convenience links and attachment tabs. Reinstall the bumper, wheel well covers, tires, fascia, antenna, hood, plastic covers below the doors.

If the vehicle is equipped with a front license plate, move the bolts holding the bracket to a higher position after the installation of the baseplate.

BX1987  
2008-2015 Smart Car  
Installation Instructions



**CUSTOMER SERVICE COMMITMENT**

Blue Ox® is committed to providing you with exceptional customer care throughout your lifetime with our products. Our team is here to assist you with any questions you may have regarding the performance of your product. Simply call (402) 385-3051 and you can speak with our technical service team.

Additionally, please visit our website to see which rallies our Destination America team will be attending. For a nominal fee, our service technician will service your towing system to ensure it's in proper working condition. Also, as a commitment to our customers, should you visit our factory, you can stay at our full service Blue Ox® campground at no charge along with enjoying a factory tour.

Again, thank you for being our customer and for the confidence you have shown in the performance of our products. It is because of customers like you we enjoy the success we have today.

© 2022 Blue Ox  
One Mill Road, Industrial Park  
Pender, Nebraska 68047  
Phone: (402) 385-3051  
Fax: (402) 385-3360  
[www.blueox.com](http://www.blueox.com)

# General Information

1. Ensure that your product(s) are registered online at [www.blueox.com](http://www.blueox.com). It is crucial to register your product(s) so that you may be alerted of product offerings, updates, upgrades, maintenance and safety bulletins, and/or recalls.
2. **It is the owner's responsibility to inspect all towing equipment for cracked welds, missing or worn parts and loose bolts before each towing trip.** Be sure to use Loctite® Red on all bolts and tighten to the recommended specifications.
3. **It is the owner's responsibility to hook up all towing equipment per manufacturer's instructions/recommendations.**
4. Remove the attachment tabs when not in use (if applicable).

## Notice To Baseplate Installer

### 1. It is YOUR responsibility to watch for:

- Oil cooler and air conditioner lines
- Electrical wires and hoses
- Missing parts or attaching points on the frame

\*\* If the baseplate is improperly installed and is against a wire or hose, it could cause fluid leaks or electrical shorts some time after the actual baseplate installation.

## Permanent Baseplate Safety Cable Installation

Permanent baseplate safety cables are strongly recommended when towing a vehicle with a tow bar. The principle function of the permanent baseplate safety cables is to prevent the towed vehicle from breaking loose in the event the connection between the frame of the towed vehicle and the baseplate fails or becomes disconnected. The cables must be connected from the baseplate to the frame rail or cross member of the vehicle's frame. The illustrations below show the possible arrangements recommended by Blue Ox®. Each permanent baseplate safety cable must have an adequate weight rating for the towing system. The weight rating of the two (2) cables together will not qualify.

***Do not mount the permanent baseplate safety cables against wires, hoses or brake lines.***

These permanent baseplate safety cables should remain installed as long as the baseplate is installed on the vehicle. Permanent baseplate safety cables are to be used in conjunction with, and NOT a replacement for legally required safety cables attaching the towed vehicle to the towing vehicle.

### Option #1

(Baseplates with Convenience Link Tabs)

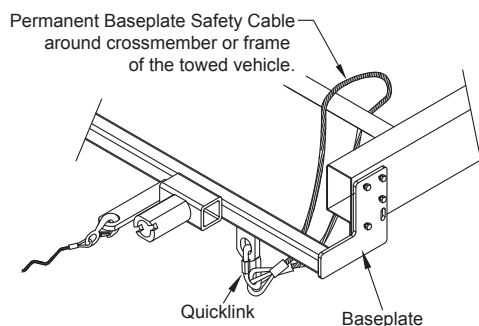

### Option #2

(Baseplates with out Convenience Link Tabs)

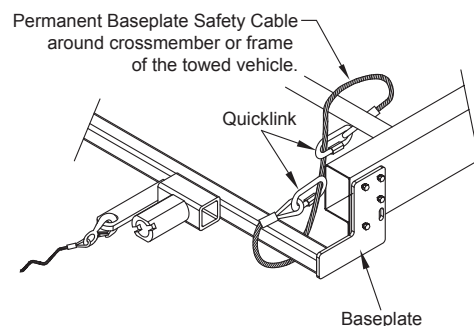

# BLUE OX ORIGINAL PURCHASERS THREE YEAR LIMITED WARRANTY

Automatic Equipment Manufacturing Company ("Automatic") warrants to the original (first) retail purchaser that this product, manufactured by Automatic, shall be free from defect in material and workmanship under normal use and service for a period of three years from the date of delivery.

During said three-year period, Automatic will repair or replace any parts that have been returned by the original purchaser, to the factory, transportation prepaid, and in Automatic's sole and absolute opinion found to be defective.

Limitations on Warranty Coverage:

Coverage under this warranty will be valid only if the customer warranty card is returned by the original purchaser within 30 days of purchase.

Coverage under this warranty will be effective only when a copy of the original invoice, showing date and place of purchase, accompanies any claim for warranty. This warranty is NON TRANSFERABLE.

This limited warranty will not cover, in any way or form, any alleged damages caused by incorrect or improper installation, improper use, modification or neglect of product, failure to properly service and maintain, misuse, act of God, accident or failure of the user to follow guidelines contained in the instructional material provided by Automatic.

This warranty does not cover normal wear and tear, paint or rust.

Warrantor assumes no responsibility to the owner for loss of use of product, loss of time, inconvenience or any other damage consequential or otherwise. Including, but not limited to mileage, expense of transporting of product, return shipping expense, mechanics travel time, telephone, road service, towing, and rental during repairs, travel, lodging, loss or damage to personal property or loss of earnings.

**REPAIR OR REPLACEMENT AS SET FORTH IN THIS LIMITED WARRANTY IS THE SOLE EXCLUSIVE REMEDY OF THE PURCHASER. AUTOMATIC SHALL NOT BE LIABLE FOR ANY INCIDENTAL OR CONSEQUENTIAL DAMAGES FOR BREACH OF ANY EXPRESS OR IMPLIED WARRANTY ON THIS PRODUCT. EXCEPT TO THE EXTENT PROHIBITED BY APPLICABLE LAW, ANY IMPLIED WARRANTY OF MERCHANTABILITY OR FITNESS FOR A PARTICULAR PURPOSE ON THIS PRODUCT IS LIMITED IN LENGTH TO THE DURATION OF THIS WARRANTY.**

Please visit <http://blueox.com/warranty/> to register your warranty



**BLUE OX**