



# BX1512

## 2006-11 Buick Lucerne Installation Instructions

Serial Number

Please read BOTH these Installation Instructions and the General Towing Instructions before attempting to install or operate this equipment.

- Blue Ox® towing products and accessories are intended to be installed by Blue Ox® Dealers who are familiar with our products and have the equipment and knowledge to do “fit work”. When necessary, Blue Ox® Dealers can be found at [www.blueox.com](http://www.blueox.com) or by contacting our Customer Care Department at (402) 385-3051.
- Many Blue Ox® Baseplates are designed to use existing holes and hardware to mount the baseplate to the towed vehicle. Even though bolts are there, do not assume they are adequate for baseplate mounting. Always use hardware supplied in the hardware kit or existing hardware specified in the Baseplate Installation Instructions.

Attachment Tab Height: 12-1/2”

Attachment Tab Width: 30”

### Bolt Torque Specifications

Torque in Foot-Pounds for Metric Bolts

| Bolt Size | Grade 8.8 | Grade 10.9 |
|-----------|-----------|------------|
| 6MM       | 6         | 8          |
| 8MM       | 16        | 22         |
| 10MM      | 31        | 40         |
| 12MM      | 54        | 70         |
| 14MM      | 89        | 117        |

Confirm the towability and pre-towing procedures for your vehicle with the owner’s manual or contact the vehicle’s manufacturer for specific towing procedures.

### Bolt Torque Specifications

Torque in Foot-Pounds for Inch Bolts

| Bolt Size | Grade 5 | Grade 8 |
|-----------|---------|---------|
| 1/4”      | 10      | 14      |
| 5/16”     | 19      | 29      |
| 3/8”      | 33      | 47      |
| 7/16”     | 54      | 78      |
| 1/2”      | 78      | 119     |
| 5/8”      | 154     | 230     |



If the front of your vehicle looks different than this, call us at (402) 385-3051.



## WARNING

Failure to read and follow these instructions could result in separation of the towed vehicle from the tow bar, causing property damage, loss of towed vehicle, personal injury or death.

BX1512  
2006-11 Buick Lucerne  
Installation Instructions

## Parts List

| Ref. No. | Qty. | Part #   | Description                                     |
|----------|------|----------|---|
| 1        | 1    | 61-6302  | Weldment, Cross Tube, BX1512                    |
| 2        | 1    | 61-6279  | Weldment, Plate End, DS, BX1511                 |
| 3        | 1    | 61-6280  | Weldment, Plate End, PS, BX1511                 |
| 4        | 2    | 61-3799  | 1/2-13 Nut Plate, with 10" Wire                 |
| 5        | 4    | 61-5208  | 3/8-16 Nut Plate with 14" Wire                  |
| 6        | 2    | 201-0153 | 1/2-13 x 2 1/2" Bolt, Grd. 5, ZP                |
| 7        | 4    | 201-0011 | 1/2-13 x 1 1/4" Bolt, Grd. 5, ZP                |
| 8        | 4    | 201-0336 | 3/8-16 x 2 1/2" Bolt, Grd. 5, ZP                |
| 9        | 6    | 203-0012 | 1/2" Lock Washer, ZP                            |
| 10       | 4    | 203-0010 | 3/8" Lock Washer, ZP                            |
| 11       | 2    | 202-0005 | 1/2-13 Hex Nut, ZP                              |
| 12       | 1    | 101-6135 | Electrical Bracket, 90 Degr.                    |
| 13       | 4    | 201-0050 | 1/4-20 x 3/4 Hex Bolt, Grd. 5, ZP               |
| 14       | 4    | 203-0008 | 1/4" Lock Washer                                |
| 15       | 2    | 203-0001 | 1/4" Flat Washer                                |
| 16       | 4    | 202-0069 | 1/4-20 Whiz Hex Nut, ZP                         |
| 17       | 2    | 201-0192 | #10-32 x 1/2 Slot, Rd. Hd. Screw                |
| 18       | 2    | 203-0054 | #10 Lock Washer                                 |
| 19       | 2    | 202-0047 | #10-32 Hex Nut                                  |
| 20       | 2    | 101-5822 | Adapter, 4 Way Connector                        |
| 21       | 2    | 62-3469  | Attachment, Assembly, SF/LB (R)                 |
|          | 2    | 201-0443 | 3/8-16 x 1" Hex Bolt, Grd. 5, ZP (Not Shown)    |
|          | 2    | 202-0071 | 3/8-16 Hex Flange Whiz Lock Nut, ZP (Not Shown) |
|          | 2    | 226-0046 | Baseplate Safety Cable, 36" CL III (Not Shown)  |
|          | 2    | 229-0359 | Quicklink, 3/8, ZP (Not Shown)                  |
|          | 2    | 290-0437 | Receiver, Cap Plug, Blk. (Not Shown)            |

### Tools Required

3/4" Socket/Wrench  
10mm Socket  
13mm Socket  
15mm Socket  
13/32" Drill Bit  
Reciprocating Saw  
Tape Measure  
Utility Knife  
Loctite® RED

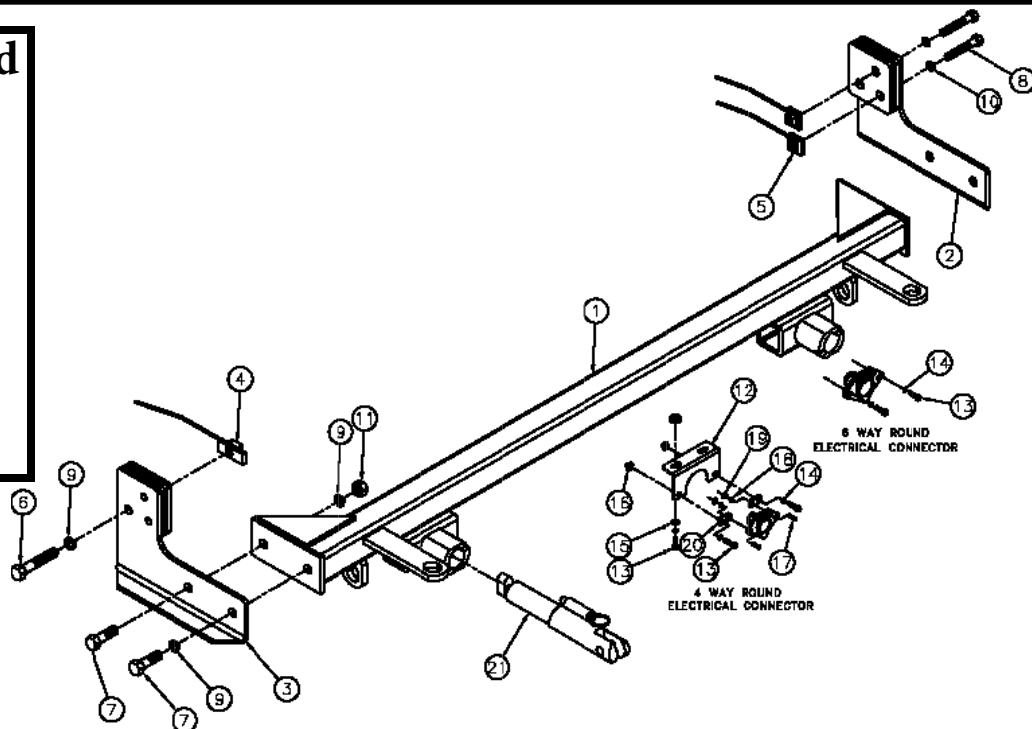

### Important:

Use only genuine factory replacement parts on your baseplate. Do **NOT** substitute homemade or non-typical parts. If a bolt is lost or in need of replacement, for your safety and the preservation of your baseplate, be sure to use a replacement bolt of the same grade (In most cases it will be Grade 5, please reference the parts list above). Replacement parts may be ordered through your nearest Blue Ox® Dealer or Distributor. Failing to follow and/or altering these installation instructions in either installation or required equipment will void the manufacturer's warranty. Towing behind a non-motorized vehicle will void the warranty.

BX1512  
2006-11 Buick Lucerne  
Installation Instructions

**Attachment Tabs:**

Due to the design of the removable tabs, the RangeFinderII and Ambassador tow bars can not be used. Adapters, except the BX8833 and BX88151, can not be used with this baseplate.

**Installation Notes:**

The radiator cover, fascia, belly pan and metal bumper are removed for installation. The fascia support is trimmed. Drilling is required. Bumper bracket bolts are not reinstalled.

The dimensional variations between otherwise identical vehicles can be considerable. While the baseplate was designed for easy installation, it may be necessary to tailor the baseplate slightly to compensate for auto manufacturer's tolerances. These minor adjustments may include filing a hole slightly, bending electrical rods or bending end plates.

The BX8869 Bulb and Socket Wiring Kit is recommended for this vehicle.

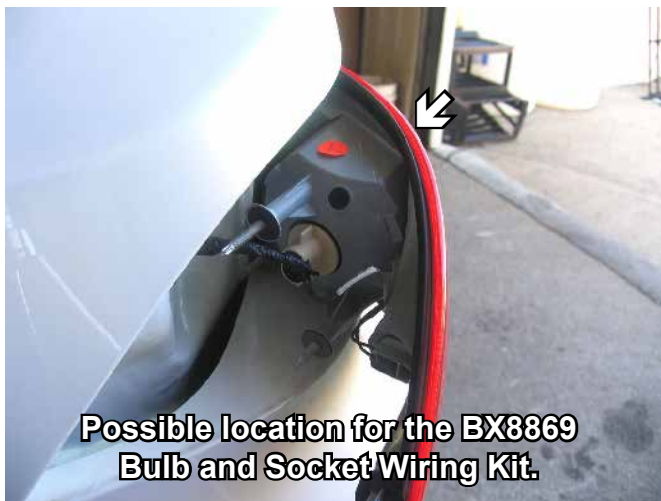

**Installation Instructions**



1. Remove four (4) pushpins from the radiator cover and lift to remove. Do this to both sides of the vehicle. Set pushpins and radiator cover aside to be reinstalled later.

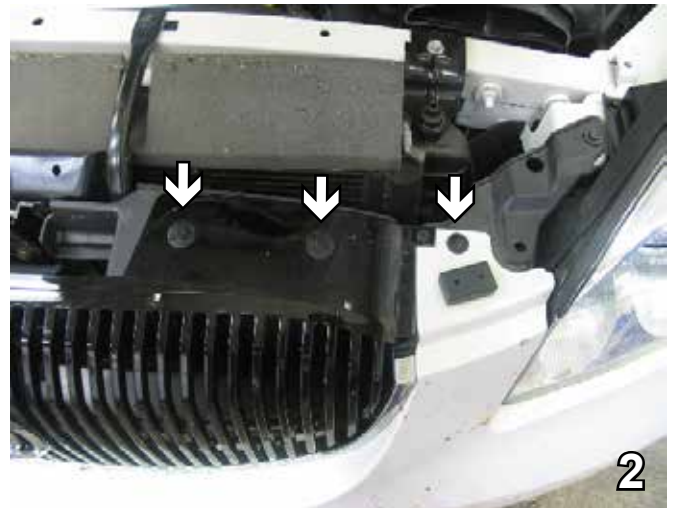

2. Remove three (3) pushpins from the top of the fascia. Do this to both sides of the vehicle. Set pushpins aside to be reinstalled later.

Handling of some cosmetic parts when installing this product may require the use of protective covers, rags, specialty tools, etc. to prevent damage.

BX1512  
2006-11 Buick Lucerne  
Installation Instructions



3. Remove five (5) pushpins just forward of the front tire, on the edge of fascia. Do this to both sides of the vehicle. Set pushpins aside to be reinstalled later.

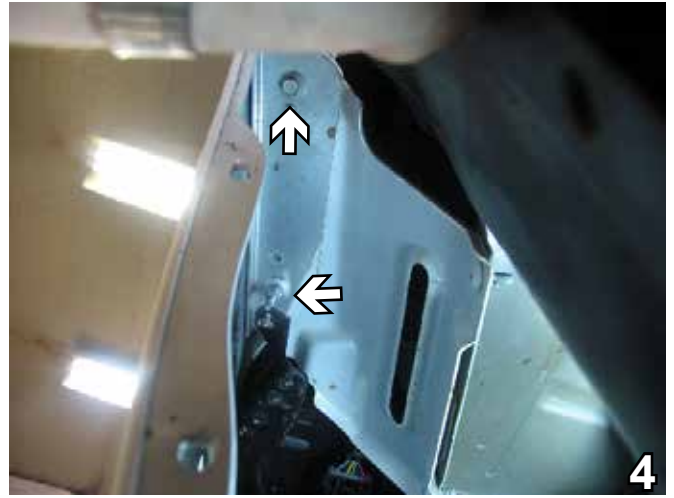

4. Pull wheel well cover aside and remove two (2) metric bolts from back side of fascia using the 10mm socket. Do this to both sides of the vehicle. Set bolts aside to be reinstalled later.



5. Remove four (4) pushpins from the bottom corner of fascia. Do this to both sides of the vehicle. Set pushpins aside to be reinstalled later.



6. Remove two (2) pushpins from the bottom center of fascia. Pull fascia forward to remove. Set pushpins and fascia aside carefully to be reinstalled later.



BX1512  
2006-11 Buick Lucerne  
Installation Instructions

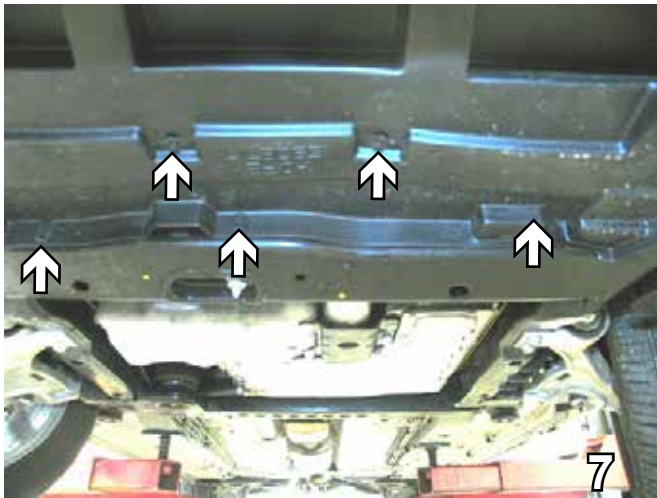

7. Remove five (5) pushpins from the belly pan. Set pushpins and belly pan aside to be reinstalled later.



8. Under hood latch area (see inset), disconnect two (2) electrical connections and move out of the way. Using the 13mm socket, remove four (4) metric bolts from the metal bumper. Do this to both sides of the vehicle. Set bolts aside to be reinstalled later.



9. Remove one (1) pushpin fastening the lower section of air dam to the top of the metal bumper. Do this to both sides of the vehicle. Pull metal bumper forward to remove. Set pushpins and metal bumper aside to be reinstalled later.



10. Mark a rectangle on the lower portion of bumper bracket. Start horizontally below the upper portion of bumper bracket (see white arrow) and continue just beyond the lower bolt hole. Then, mark straight down until reaching bottom of frame rail. This vertical marking should be flush with frame rail edge (behind bumper bracket). Using the reciprocating saw, cut marked area through the bumper bracket and frame rail.

BX1512  
2006-11 Buick Lucerne  
Installation Instructions



11. Using the utility knife, remove three (3) tabs from the lower edge of fascia support. *Note: To prevent scratching, fascia should be lying on a smooth surface.*

**BE SURE TO USE LOCTITE® RED ON ALL BOLTS BEFORE TIGHTENING. TIGHTEN ALL BOLTS ACCORDING TO THE TORQUE CHART ON THE FRONT PAGE OF THESE INSTRUCTIONS OR ON PAGE 3 OF THE BASEPLATE TOWING GENERAL INSTRUCTIONS.**



13. Align endplate with existing hole of the frame rail. Insure top of endplate is parallel with frame rail. Insert 1/2"-13 nut plate into frame rail opening (see white arrow) and align to pre-existing hole. Insert 1/2"-13 x 2-1/2" bolt and 1/2" lock washer and tighten (see grey arrow). Do this to both sides of the vehicle.



12. Remove the fascia support from the back of the fascia. Using the utility knife, start a vertical cut 7-1/2" in from the fascia support's inside edge. Cut upward until stopped by molding. Then, cut horizontally until reaching the inside edge. Do this to both sides of the vehicle. Reinstall fascia support to the back of fascia.

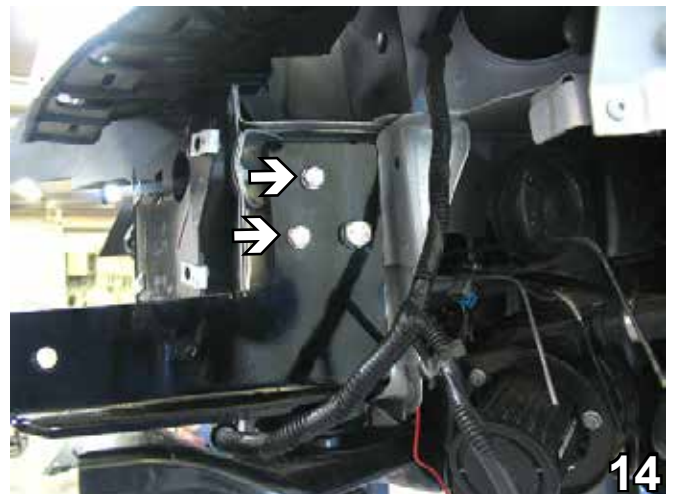

14. Using the endplate as a template, drill two holes into the frame with the 13/32" drill bit. Insert 3/8"-16 nut plates into frame rail opening and align to drilled holes. Insert 3/8"-16 x 2-1/2" bolts and 3/8" lock washers into holes and tighten. Do this to both sides of the vehicle.

**When using power drills be aware of the dangers of torque and drill bit length.**



BX1512  
2006-11 Buick Lucerne  
Installation Instructions



15. Place cross tube between the endplates (see grey arrows). Insert 1/2"-13 x 1-1/4" bolts into the endplate's two (2) front holes (see white arrows of inset). Tighten the forward most bolt and 1/2" lock washer to the weld nut in the cross tube. Tighten the other front bolt to the 1/2" lock washer and 1/2"-13 hex nut. Do this to both sides of the vehicle.

16. When reinstalling electrical connections under hood latch area, the tab-style connector goes to it's original location (see grey arrow). Snap the other connector into place (see white arrow), entering from the backside of it's bracket (rather than from the front).

Be sure that **ALL** electrical connections are plugged in properly and functioning **BEFORE** installing the fascia.

**DEALER or INSTALLER:**  
Be certain the user receives the instruction sheets for their products.

17. Reinstall belly pan, metal bumper, fascia, radiator cover, pushpins and bolts.

Install the tow bar and safety cables according to the instructions provided in their packages. When demonstrating this to the customer, be sure to include all the contents and packages.

Do **NOT** substitute other devices if the tow bar pins and clips are misplaced.

18. When replacing the fascia on the vehicle, the fascia will need to be trimmed to fit the removable tabs through.



BX1512  
2006-11 Buick Lucerne  
Installation Instructions



**Shown without removable tabs installed.**

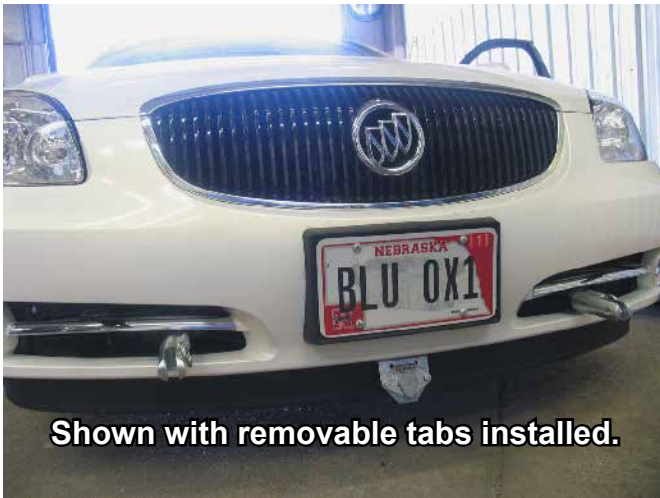

**Shown with removable tabs installed.**

If the baseplate is in an accident, it must be replaced. DO NOT use it again! An accident can cause unseen damage and using it again could result in more damage or serious injury. DO NOT use the baseplate if it is damaged or missing parts.

**CUSTOMER SERVICE COMMITMENT**

Blue Ox is committed to providing you with exceptional customer care throughout your lifetime with our products. Our team is here to assist you with any questions you may have regarding the performance of your product. Simply call (402) 385-3051 and you can speak with our customer care team.

Additionally, please visit our website to see which rallies our Destination America team will be attending. For a nominal fee, our service technician will service your towing system to ensure it's in proper working condition. Also as a commitment to our customers, should you visit our factory you can stay at our full service Blue Ox campground at no charge along with enjoying a factory tour.

Again thank you for being our customer and for the confidence you have shown in the performance of our products. It is because of customers like you we enjoy the success we have today.



© 2006, 07, 08, 09, 10 Blue Ox  
One Mill Road, Industrial Park  
Pender, Nebraska 68047  
Phone: (402) 385-3051 • Fax: (402) 385-3360  
[www.blueox.com](http://www.blueox.com)



# General Information

1. Ensure that your product(s) are registered online at [www.blueox.com](http://www.blueox.com). It is crucial to register your product(s) so that you may be alerted of product offerings, updates, upgrades, maintenance and safety bulletins, and/or recalls.
2. **It is the owner's responsibility to inspect all towing equipment for cracked welds, missing or worn parts and loose bolts before each towing trip.** Be sure to use Loctite® Red on all bolts and tighten to the recommended specifications.
3. **It is the owner's responsibility to hook up all towing equipment per manufacturer's instructions/recommendations.**
4. Remove the attachment tabs when not in use (if applicable).

## Notice To Baseplate Installer

### 1. It is YOUR responsibility to watch for:

- Oil cooler and air conditioner lines
- Electrical wires and hoses
- Missing parts or attaching points on the frame

\*\* If the baseplate is improperly installed and is against a wire or hose, it could cause fluid leaks or electrical shorts some time after the actual baseplate installation.

## Permanent Baseplate Safety Cable Installation

Permanent baseplate safety cables are strongly recommended when towing a vehicle with a tow bar. The principle function of the permanent baseplate safety cables is to prevent the towed vehicle from breaking loose in the event the connection between the frame of the towed vehicle and the baseplate fails or becomes disconnected. The cables must be connected from the baseplate to the frame rail or cross member of the vehicle's frame. The illustrations below show the possible arrangements recommended by Blue Ox®. Each permanent baseplate safety cable must have an adequate weight rating for the towing system. The weight rating of the two (2) cables together will not qualify.

***Do not mount the permanent baseplate safety cables against wires, hoses or brake lines.***

These permanent baseplate safety cables should remain installed as long as the baseplate is installed on the vehicle. Permanent baseplate safety cables are to be used in conjunction with, and NOT a replacement for legally required safety cables attaching the towed vehicle to the towing vehicle.

### OPTION #1

Permanent Baseplate Safety Cables to Cross Member or Frame of Towed Vehicle.



### OPTION #2

Permanent Baseplate Safety Cables to Cross Member or Frame of Towed Vehicle.

