



BX1516

2011-2013 Buick Regal Installation Instructions

Please read BOTH these Installation Instructions and the General Instructions before attempting to install or operate this equipment.

Serial Number

1. Blue Ox® towing products and accessories are intended to be installed by Blue Ox® Dealers who are familiar with our products and have the equipment necessary and knowledge to do “fit work”. When necessary Blue Ox® Dealers can be found at www.blueox.com or by contacting our Customer Care Department at (402) 385-3051.
2. Many Blue Ox® baseplates are designed to use existing holes and hardware to mount the baseplate to the towed vehicle. Even though bolts are there, do not assume they are adequate for baseplate mounting. Always use hardware supplied in the hardware kit and existing hardware specified in the Baseplate Installation Instructions.

Attachment Tab Height: 12”
Attachment Tab Width: 20”

Bolt Torque Specifications		
Torque in Foot-Pounds for Metric Bolts		
Bolt Size	Grade 8.8	Grade 10.9
6MM	6	8
8MM	16	22
10MM	31	40
12MM	54	70
14MM	89	117

Confirm the towability and pre-towing procedures for your vehicle with the owner’s manual or contact the vehicle’s manufacturer for specific towing procedures.

Bolt Torque Specifications		
Torque in Foot-Pounds for Inch Bolts		
Bolt Size	Grade 5	Grade 8
1/4”	10	14
5/16”	19	29
3/8”	33	47
7/16”	54	78
1/2”	78	119
5/8”	154	230



If the front of your vehicle looks different than this, call us at (402) 385-3051.

! WARNING

Failure to read and follow these instructions could result in separation of the towed vehicle from the tow bar, causing property damage, loss of towed vehicle, personal injury or death.



BX1516

2011-2013 Buick Regal Installation Instructions

Parts List

Ref. No.	Qty.	Part #	Description
1	1	61-6819	Weldment, BP, BX1516
2	8	61-5208	Weldment, Nut Plate, 1/4 X 1 X 1, 3/8" with 14" Wire
3	4	101-7542	Backing Plate, BX1516
4	8	201-0444	3/8-16 X 2 Hex Bolt Grade 5, ZP
5	8	203-0010	3/8 Lock Washer
6	2	201-0979	#12-14 x 1" Self Drilling Screw, ZP
7	2	201-0192	10-32 X 1/2 Slot, RD. HD. Screw
8	2	203-0054	#10 Lock Washer
9	2	202-0047	#10 Hex Nut
10	2	101-5822	Adapter, 4 Way Connector
11	2	62-3469	Att Tab Assembly, Rem, SF/LB, 1 Hole
12	1	102-7131	Breakaway Bracket, BX1516
13	2	201-0654	#10-16 X 1 Self Drilling Screw
14	1	201-0050	1/4-20 X 3/4 Hex Bolt Grade 5, ZP
15	1	202-0102	1/4-20 Hex Nyl Nut, ZP
	2	226-0046	Baseplate Safety Cable, 36" CL III (Not shown)
	2	229-0359	Quicklink, 3/8, ZP (Not shown)
	2	290-0437	Receiver, Cap Plug, Black (Not shown)

Tools Required

7mm Socket
 13mm Socket/Wrench
 7/16" Socket/Wrench
 9/16" Socket/Wrench
 T15 Torx
 T20 Torx
 Large Vise Grip
 Drill
 Flat Screwdriver
 Utility Knife
 Torque Wrench
 Tape Measure
 Hack Saw Blade
 13/32" Drill Bit
 Loctite® RED

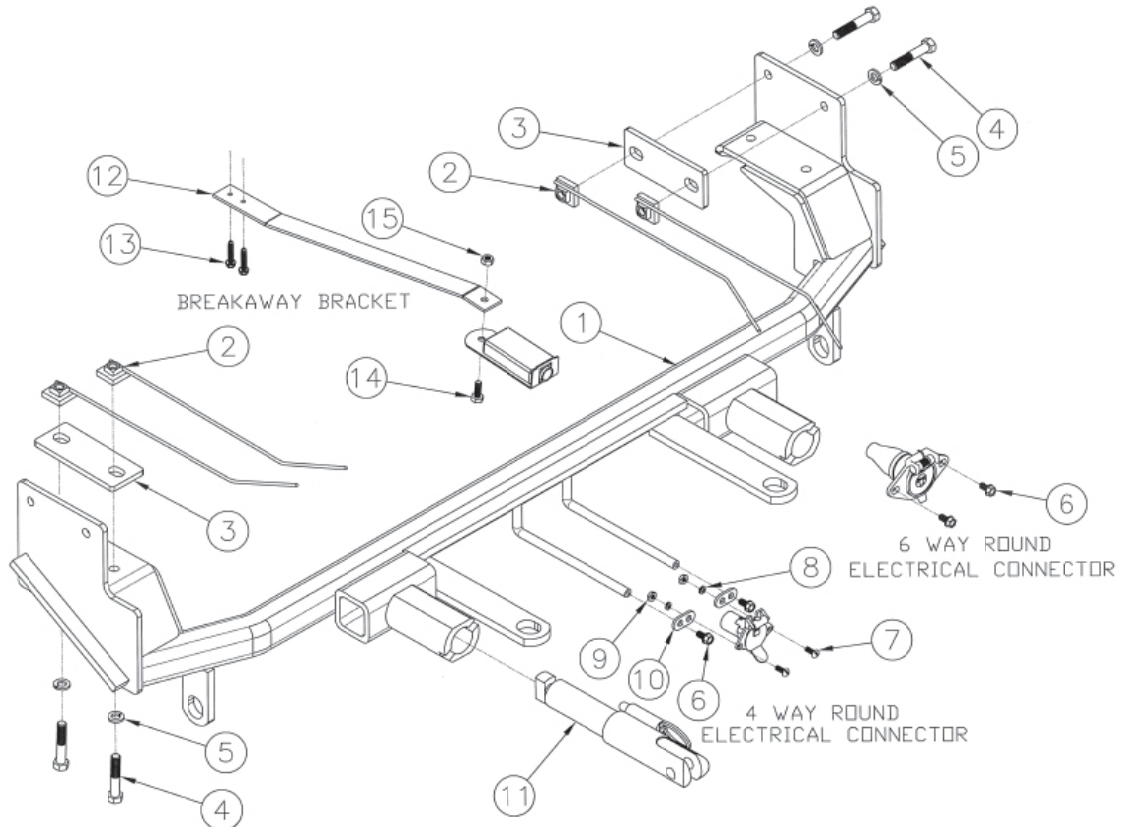

Important:

Use only genuine factory replacement parts on your baseplate. Do **NOT** substitute homemade or non-typical parts. If a bolt is lost or in need of replacement, for your safety and the preservation of your baseplate, be sure to use a replacement bolt of the same grade (In most cases it will be Grade 5, please reference the parts list above). Replacement parts may be ordered through your nearest Blue Ox® Dealer or Distributor. Failing to follow and/or altering these installation instructions in either installation or required equipment will void the manufacturer's warranty. Towing behind a non-motorized vehicle will void the warranty.



BX1516

2011-2013 Buick Regal Installation Instructions

Attachment Tabs: Motorhome mount tow bars are recommended for use with this baseplate. Due to the design of the removable tabs, the RangeFinderII and Ambassador tow bars can not be used. Adapters, except the BX8833 and BX88151 can not be used with this baseplate.

Installation Notes: The fascia, horn, air baffle and bumper are removed for installation. Drilling is required.

The dimensional variations between otherwise identical vehicles can be considerable. While the baseplate was designed for easy installation, it may be necessary to tailor the baseplate slightly to compensate for auto manufacturer's tolerances. These minor adjustments may include filing a hole slightly, bending electrical rods or bending end plates.

The BX8848 4-Diode Wiring Kit is recommended for this vehicle.

Handling of some cosmetic parts when installing this product may require the use of protective covers, rags, specialty tools, etc. to prevent damage.

Do not use the towed vehicle for storing luggage, equipment, etc. This may cause you to exceed the towing capacity of the tow bar, baseplate, and its accessories.

Installation Instructions:



1. Using a T20 torx remove three bolts on each side from the plastic piece covering the top front of the under carriage. Set the plastic piece and the bolts aside for later reinstallation.
2. Forward of the front tire on the edge of the fascia, using a T20 torx, remove the three screws. Do this on both sides. Set the screws aside for later reinstallation.

BX1516
2011-2013 Buick Regal
Installation Instructions



3. On the driver side only, underneath the plastic covering use a 8MM socket to remove one bolt in the corner. Set the bolt aside to be reinstalled later.
4. Remove the four push pins from under the center front of the fascia. Set fascia and push pins aside carefully for later reinstallation.

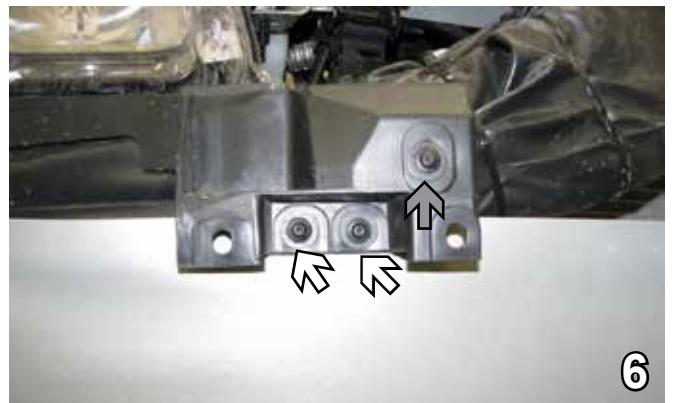
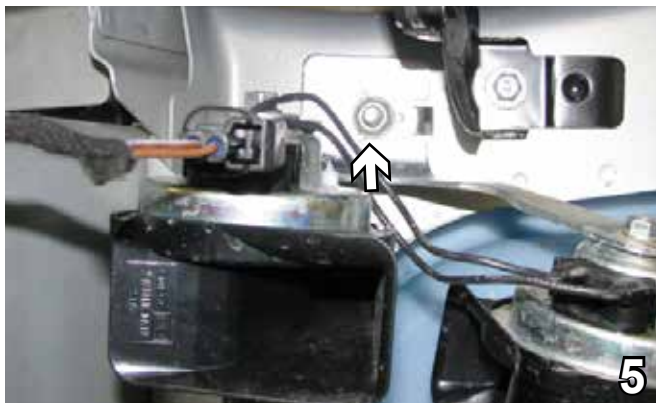

5. Use a 13MM socket to remove one bolt from the horn bracket and unplug. Set the horn aside to be reinstalled later.
6. Using a T15 Torx, remove the two screws on the front of the headlight. Do this to both sides. On the passenger side, remove the additional screw (gray arrow) from the air vent. Set aside for later reinstallation.

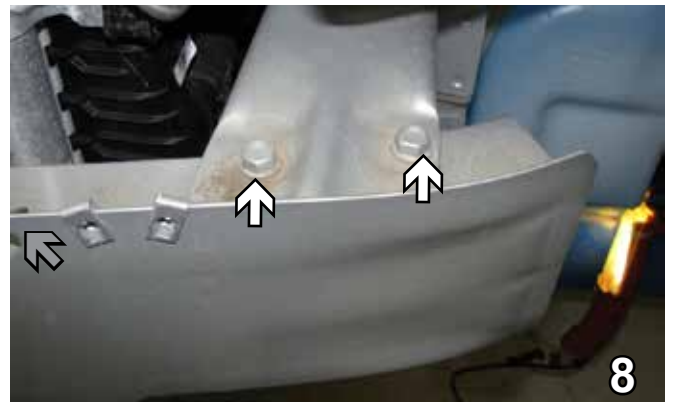

7. On the passenger side, remove the push pin from the air vent. Set aside bolts for later reinstallation.
8. Remove the clip holding the sensor to the top of the bumper (gray arrow). Using a 13MM socket, remove two bolts from each side of the bumper. Do this to both sides. Pull the bumper forward and set it aside until later reinstallation.

BX1516
2011-2013 Buick Regal
Installation Instructions



9. Slide the baseplate up and clamp it to the frame rail. Using the baseplate as a template, with a 13/32" drill bit, drill the side holes. Do this to both sides.
10. Be very careful with the coolant line on the passenger side. If the baseplate hits the line, it will need to be bent. On the passenger side, use a long drill bit on the front hole and cover the drill bit with a tube to prevent damage to the coolant line. Use a 13/32" drill bit on both sides.

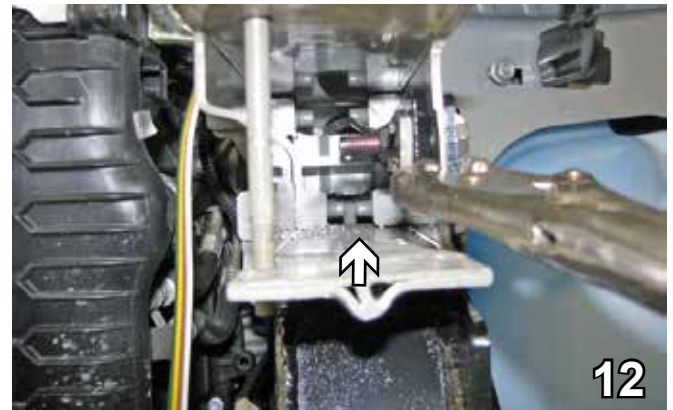
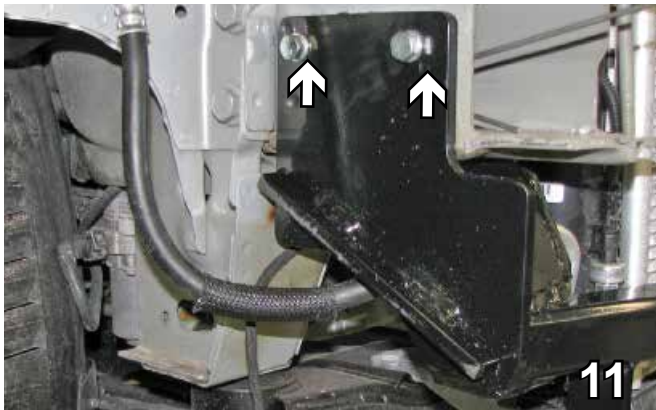

11. Insert 3/8-16 x 2" bolts and 3/8" lock washers into the side holes. Attach to backing plates and 3/8-16 nut plates inserted inside the frame end. Use Loctite on the bolts and tighten to specs. Do this to both sides.
12. Insert 3/8-16 x 2" bolts from underneath and 3/8" lock washers on the bottom. Slide the backing plate inside the frame end and attach to 3/8-16 nut plates. Use Loctite on the bolts and tighten to specs. Do this to both sides.

BE SURE TO USE LOCTITE® RED ON ALL BOLTS BEFORE TIGHTENING. TIGHTEN ALL BOLTS ACCORDING TO THE TORQUE CHART ON THE FRONT PAGE OF THESE INSTRUCTIONS OR ON PAGE 3 OF THE BASEPLATE TOWING GENERAL INSTRUCTIONS.

When using power drills be aware of the dangers of torque and drill bit length.

BX1516
2011-2013 Buick Regal
Installation Instructions

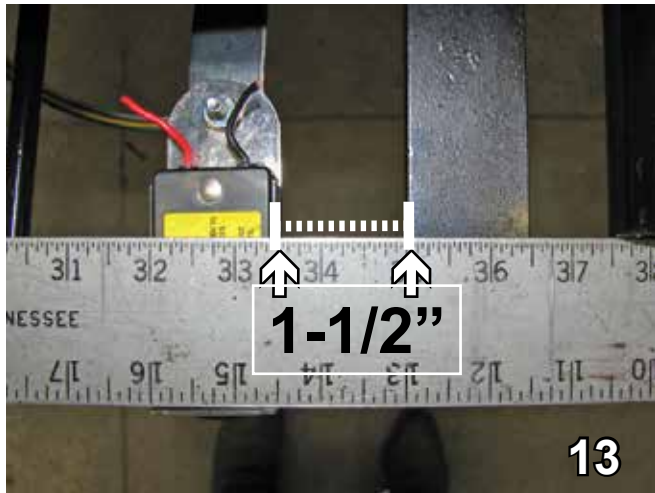

13. Position the breakaway bracket 1 1/2" away from the convenience link.



14. Trim the plastic just below the radiator to accommodate the bracket.

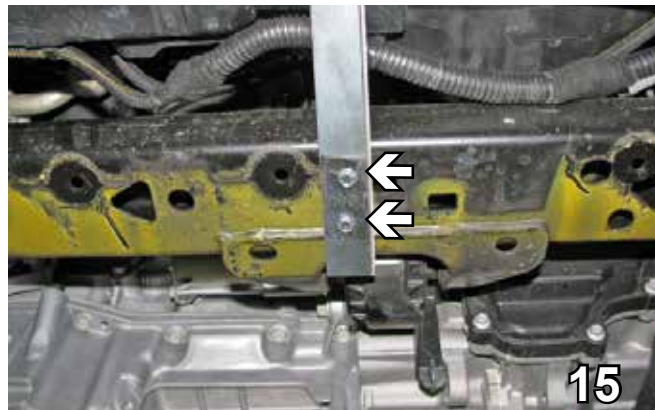

15. Attach the breakaway bracket to the frame cross member with two 10-16 x 1" self drilling screws.

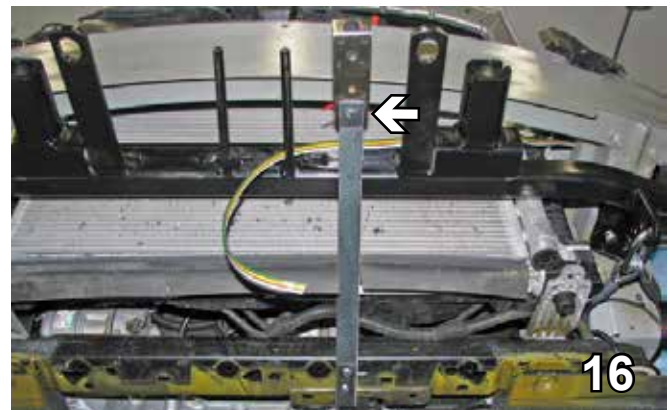

16. Attach the breakaway to the bracket with 1/4-20 x 3/4" hex bolt and 1/4-20 hex nut.



17. Attach the permanent baseplate safety cables to the provided convenience link on the baseplate. The photo above shows the recommended installation of the cables to frame of vehicle. Additional options may interfere with suggested mounting; in this case secure the cables to a solid piece of the frame as described in the instructions included with the permanent baseplate safety cables. Be sure the safety cables do not rub against any hoses or moving parts. Do this to both sides of the vehicle.

18. Reinstall the horn, air baffle and the metal bumper before reinstalling the fascia, push pins and bolts.

Install the tow bar and safety cables according to the instructions provided in their packages. When demonstrating this to the customer, be sure to include all the contents and packages.

Do **NOT** substitute other devices if the tow bar pins and clips are misplaced.

BX1516
2011-2013 Buick Regal
Installation Instructions

Be sure that **ALL** electrical connections are plugged in properly and functioning **BEFORE** installing the fascia.



Shown without removable tabs installed

DEALER or INSTALLER:
Be certain the user receives the instruction sheets for their products.



Shown with removable tabs installed

CUSTOMER SERVICE COMMITMENT

Blue Ox is committed to providing you with exceptional customer care throughout your lifetime with our products. Our team is here to assist you with any questions you may have regarding the performance of your product. Simply call (402) 385-3051 and you can speak with our customer care team.

Additionally, please visit our website to see which rallies our Destination America team will be attending. For a nominal fee, our service technician will service your towing system to ensure it's in proper working condition. Also, as a commitment to our customers, should you visit our factory, you can stay at our full service Blue Ox campground at no charge along with enjoying a factory tour.

Again, thank you for being our customer and for the confidence you have shown in the performance of our products. It is because of customers like you we enjoy the success we have today.

If the baseplate is in an accident, it must be replaced. DO NOT use it again! An accident can cause unseen damage and using it again could result in more damage or serious injury. DO NOT use the baseplate if it is damaged or missing parts.



© 2011 Blue Ox
One Mill Road, Industrial Park
Pender, Nebraska 68047
Phone: (402) 385-3051 • Fax: (402) 385-3360
www.blueox.com

General Information

1. Ensure that your product(s) are registered online at www.blueox.com. It is crucial to register your product(s) so that you may be alerted of product offerings, updates, upgrades, maintenance and safety bulletins, and/or recalls.
2. **It is the owner's responsibility to inspect all towing equipment for cracked welds, missing or worn parts and loose bolts before each towing trip.** Be sure to use Loctite® Red on all bolts and tighten to the recommended specifications.
3. **It is the owner's responsibility to hook up all towing equipment per manufacturer's instructions/recommendations.**
4. Remove the attachment tabs when not in use (if applicable).

Notice To Baseplate Installer

1. It is YOUR responsibility to watch for:

- Oil cooler and air conditioner lines
- Electrical wires and hoses
- Missing parts or attaching points on the frame

** If the baseplate is improperly installed and is against a wire or hose, it could cause fluid leaks or electrical shorts some time after the actual baseplate installation.

Permanent Baseplate Safety Cable Installation

Permanent baseplate safety cables are strongly recommended when towing a vehicle with a tow bar. The principle function of the permanent baseplate safety cables is to prevent the towed vehicle from breaking loose in the event the connection between the frame of the towed vehicle and the baseplate fails or becomes disconnected. The cables must be connected from the baseplate to the frame rail or cross member of the vehicle's frame. The illustrations below show the possible arrangements recommended by Blue Ox®. Each permanent baseplate safety cable must have an adequate weight rating for the towing system. The weight rating of the two (2) cables together will not qualify.

Do not mount the permanent baseplate safety cables against wires, hoses or brake lines.

These permanent baseplate safety cables should remain installed as long as the baseplate is installed on the vehicle. Permanent baseplate safety cables are to be used in conjunction with, and NOT a replacement for legally required safety cables attaching the towed vehicle to the towing vehicle.

OPTION #1

Permanent Baseplate Safety Cables to Cross Member or Frame of Towed Vehicle.

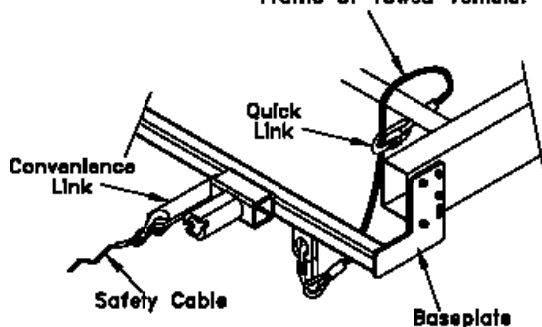

OPTION #2

Permanent Baseplate Safety Cables to Cross Member or Frame of Towed Vehicle.

