



Strong As An Ox™

## BX2234 Installation Instructions 2004-05 Honda Civic

Serial No.

The headlight assembly, front fascia and windshield washer reservoir are removed for baseplate installation. Drilling is required. The BX8869 is available for the vehicle. Attachment Tabs are 18 inches center to center and a height of 13 1/4 inches.



1. Remove the four push pins from black plastic cover on top side of fascia.



2. Remove one push pin on bottom edge of fascia just forward of front tire, both sides.



3. Using the phillips screw driver, remove one phillips screw on lower edge of fascia, both sides.



4. Remove the four push pins from lower edge of fascia.



5. Just forward of the front tire, on fascia's corner, remove one phillips screw using the phillips screw driver, both sides. Pull fascia's corner to the side and forward to remove, set fascia aside.



6. Using the 10MM socket, remove one metric bolt from head light assembly and one push pin, both sides.



Strong As An Ox™

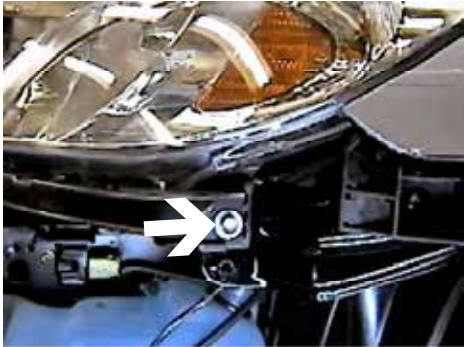

7. Using the 10MM socket, remove metric bolt from head light assembly.

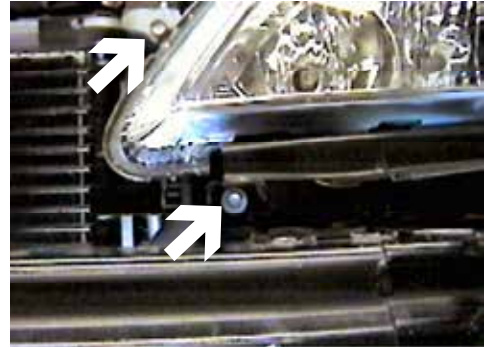

8. Remove two metric bolts from head light assembly, using the 10MM socket, pull assembly forward, unplug and set aside.

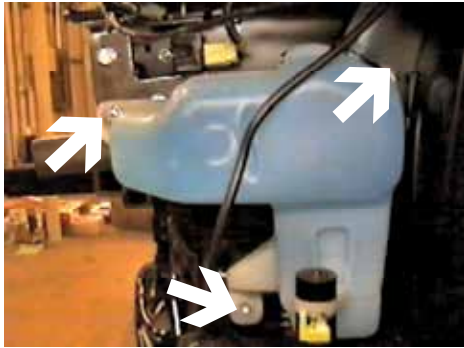

9. Remove three metric bolts from washer reservoir using the 10MM socket, pull reservoir down, unplug electrical connections, disconnect and plug water lines, set aside.

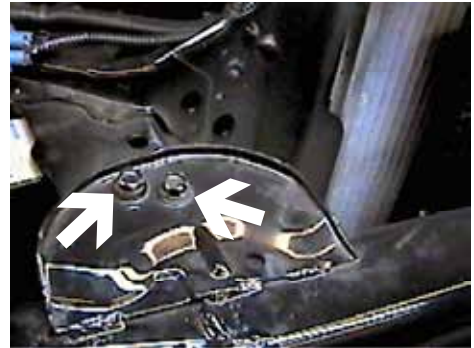

10. Using the 12MM socket, remove two metric bolts from the top and one metric bolt from the bottom metal bumper bracket, both sides, pull metal bumper forward and set aside.

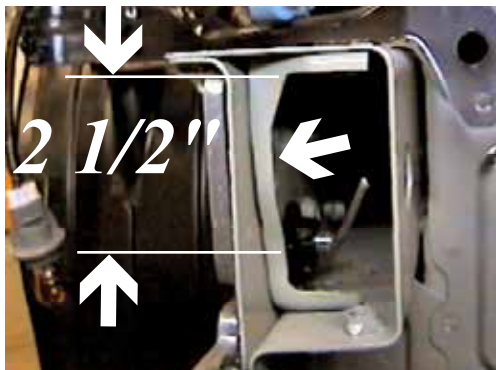

11. Cut ribbing inside of the frame end about 2 1/2" with the hack saw and flatten ribbing to frame, both sides. (See photo in step 13.)



12. Bend horn bracket back out of the way to allow enough room for baseplate, both sides.





Strong As An Ox™

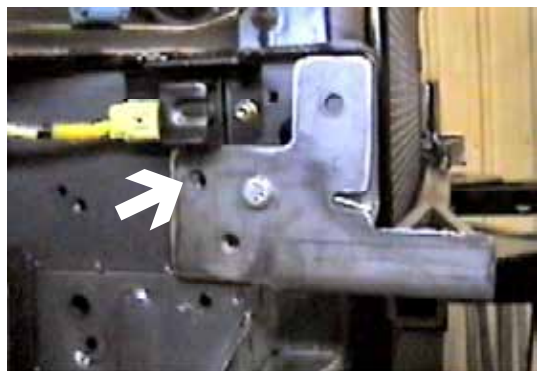

13. Align baseplate's forward slot, on driver's side, with existing front hole for washer reservoir, clamp in place with vise grips, (see arrow in photo at left). Align baseplate's back hole with existing hole on passenger's side and clamp to frame with vise grip, (see arrow in lower left photo). Using the baseplate as a template, drill all holes on the driver's side using the 13/32" drill bit. Insert 3/8" nut plate into the end of the frame (see photo lower right) to align with drilled holes, tighten 3/8" hex bolt and lock washer as shown in drawing on page 4. Using the baseplate as a template drill all holes on the passenger's side. Insert 3/8" nut plate into the end of the frame to align with drilled holes, tighten 3/8" hex bolt and lock washer as shown in drawing on page 4. **Be sure and use loctite on all bolts before tightening. Tighten all bolts according to torque chart in the General Instruction sheet.**

14. After baseplate is installed, be sure horn's housing does not make contacted with baseplate or radiator support. **The horn will not work properly if it is touching something.**
15. Reinstall washer reservoir with two back existing metric bolts and use the 6MM-1 x 30MM hex bolt in the forward mount location. Reinstall head light assemblies and fascia. **Be sure all electrical and fluid lines are plugged in properly.**
16. The dimensional variations between otherwise identical cars can be considerable. While the location and size of the holes in the baseplate were designed to allow for easy installation, it may be necessary to file a hole slightly to allow a bolt to clear.
17. Install the tow bar and safety cables according to the instructions included in their packages.
18. Do **not** substitute other devices if the tow bar pin and clip are lost.
19. **DEALER OR INSTALLER: BE CERTAIN THE USER RECEIVES THE INSTRUCTION SHEET.**



Strong As An Ox™

### Tools Required

10MM Socket  
9/16" Socket  
Phillips Screw Driver

12MM Socket  
Loctite  
Vise Grips

13MM Socket  
13/32" Drill Bit  
Hack Saw

### Parts List

Ref. No.	Qty.	Part No.	Description
1	1	61-5984	Weldment, Base Plate, BX2234
2	5	61-5208	3/8" Nut Plate, with Wire
3	7	201-0440	3/8-16 x 1 1/2 Bolt, Grd. 5, ZP
4	7	203-0010	3/8 Lock Washer, ZP
5	2	202-0003	3/8-16 Hex Nut, ZP
6	1	201-0655	6MM-1 x 30MM Hex Bolt, Grd 8.8, ZP
7	1	201-0446	8MM-1.25 x 30MM Hex Bolt, Grd 8.8, ZP
8	1	203-0102	8MM Lock Washer, ZP
9	2	203-0001	1/4 Flat Washer, ZP
10	2	201-0979	#12-14 x 1" Self Drilling Screw, ZP
11	2	202-0047	#10-32 Hex Nut
12	2	203-0054	#10 Lock Washer
13	2	201-0192	#10-32 x 1/2 Slot, Rd. Hd. Screw
14	2	101-5822	Adapter, 4 Way Connector
	2	226-0046	Baseplate Safety Cable, 36" CL III (Not Shown)
	4	229-0359	Quicklink, 3/8, ZP (Not Shown)

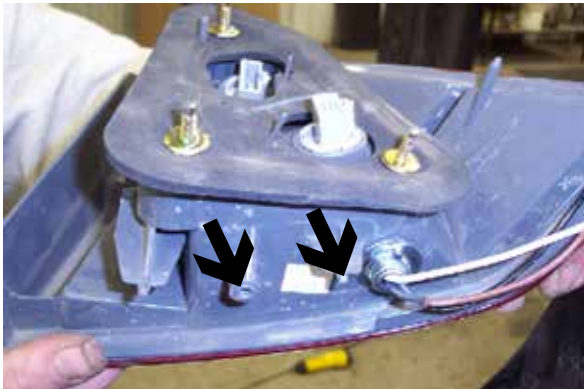

**Location on the driver's side, for the BX8869. Note bolt and pin location on the bottom of assembly that is under rear fascia.**

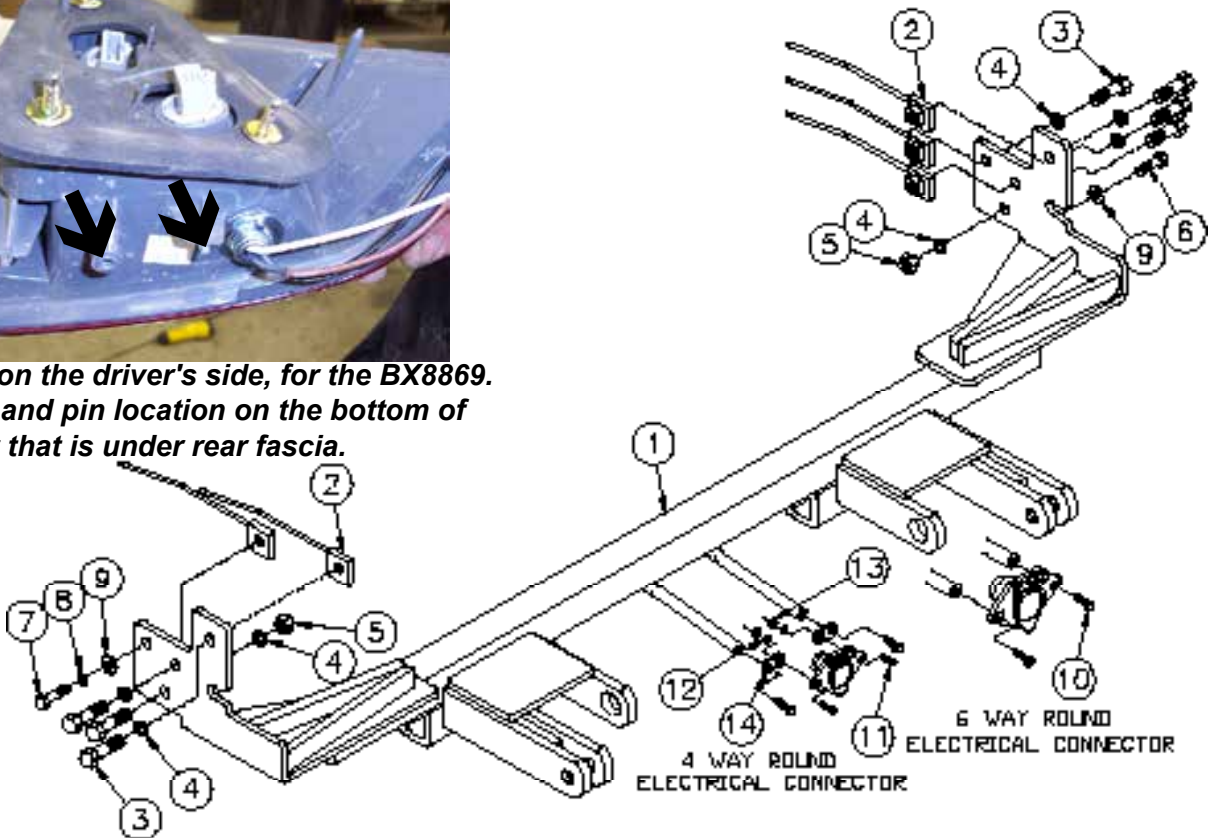

**IMPORTANT:** Use only genuine factory replacement parts on your Base Plate. Do not substitute homemade or nontypical parts. If a bolt is lost or in need of replacement, for your safety and the preservation of your Base Plate, be sure to use a replacement bolt of the same grade (Usually Grade 5, refer to parts list). Repair parts may be ordered through your nearest **Blue Ox** dealer or distributor.



# General Information

1. Ensure that your product(s) are registered online at [www.blueox.com](http://www.blueox.com). It is crucial to register your product(s) so that you may be alerted of product offerings, updates, upgrades, maintenance and safety bulletins, and/or recalls.
2. **It is the owner's responsibility to inspect all towing equipment for cracked welds, missing or worn parts and loose bolts before each towing trip.** Be sure to use Loctite® Red on all bolts and tighten to the recommended specifications.
3. **It is the owner's responsibility to hook up all towing equipment per manufacturer's instructions/recommendations.**
4. Remove the attachment tabs when not in use (if applicable).

## Notice To Baseplate Installer

### 1. It is YOUR responsibility to watch for:

- Oil cooler and air conditioner lines
- Electrical wires and hoses
- Missing parts or attaching points on the frame

\*\* If the baseplate is improperly installed and is against a wire or hose, it could cause fluid leaks or electrical shorts some time after the actual baseplate installation.

## Permanent Baseplate Safety Cable Installation

Permanent baseplate safety cables are strongly recommended when towing a vehicle with a tow bar. The principle function of the permanent baseplate safety cables is to prevent the towed vehicle from breaking loose in the event the connection between the frame of the towed vehicle and the baseplate fails or becomes disconnected. The cables must be connected from the baseplate to the frame rail or cross member of the vehicle's frame. The illustrations below show the possible arrangements recommended by Blue Ox®. Each permanent baseplate safety cable must have an adequate weight rating for the towing system. The weight rating of the two (2) cables together will not qualify.

***Do not mount the permanent baseplate safety cables against wires, hoses or brake lines.***

These permanent baseplate safety cables should remain installed as long as the baseplate is installed on the vehicle. Permanent baseplate safety cables are to be used in conjunction with, and NOT a replacement for legally required safety cables attaching the towed vehicle to the towing vehicle.

### OPTION #1

Permanent Baseplate Safety Cables to Cross Member or Frame of Towed Vehicle.



### OPTION #2

Permanent Baseplate Safety Cables to Cross Member or Frame of Towed Vehicle.

