



## BX2336

# 2013-2016 Hyundai Elantra GT/Sport Installation Instructions

**Attachment Tab Height: 14-1/2"**

**Attachment Tab Width: 20"**

**Serial Number**

**Please read BOTH these Installation Instructions and the General Information sheet prior to installing or operating this equipment.**

1. Blue Ox® towing products and accessories are intended to be installed by Blue Ox® Dealers who are familiar with our products and have the equipment and knowledge necessary to do "fit work". If needed, Blue Ox® Dealers can be found at [www.blueox.com](http://www.blueox.com) or by contacting our Technical Service Department at (402) 385-3051.
2. Many Blue Ox® baseplates are designed to use existing holes and hardware to mount the baseplate to the towed vehicle. Even though bolts are there, do not assume they are adequate for baseplate mounting. Always use the hardware supplied in the hardware kit and existing hardware as specified in the installation instructions.



If the front of your vehicle looks different than this, please contact us at (402)385-3051.

**Reference your vehicle owner's manual for manufacturer's towing specifications.**

### Bolt Torque Specifications

Torque in Foot-Pounds for Inch Bolts

Bolt Size	Grade 5	Grade 8
1/4"	10	14
5/16"	19	29
3/8"	33	47
7/16"	54	78
1/2"	78	119
5/8"	154	230
3/4"	257	380

### Bolt Torque Specifications

Torque in Foot-Pounds for Metric Bolts

Bolt Size	Grade 8.8	Grade 10.9
6MM	6	8
8MM	16	22
10MM	31	40
12MM	54	70
14MM	89	117
16MM	161	230
18MM	222	318



## WARNING

Failure to read and follow these instructions could result in separation of the towed vehicle from the tow bar, causing property damage, loss of towed vehicle, personal injury or death.

BX2336  
2013-2016 Hyundai Elantra GT/Sport  
Installation Instructions

**Vehicle Weight:** Motorhome mount tow bars are recommended for use with this baseplate. Due to the design of the removable tabs, the RangeFinder II and Ambassador tow bars can not be used. Adapters, except the BX8833 and BX88151, can not be used with this baseplate.

**Instruction Notes:** The fascia, plastic cover, air baffle, bumper, horn and windshield washer fluid reservoir are removed and reinstalled for the baseplate installation. Some drilling and trimming is required.

Place all components that are removed on a flat, sturdy surface. All items will be reinstalled unless otherwise noted after the baseplate is installed.

The dimensional variations between otherwise identical vehicles can be considerable. While the baseplate was designed for easy installation, it may be necessary to tailor the baseplate slightly to compensate for vehicle manufacturer's tolerances.

The BX8848 Diode Tail Light Wiring Kit is recommended for this vehicle.

## ***NOTICE***

- Handling of some cosmetic parts when installing this product may require the use of protective covers, rags, specialty tools, etc. to prevent damage.
- When using power drills be aware of the dangers of torque and drill bit length.
- When using a reciprocating saw be aware of objects behind the cutting surface.
- Use a good quality paint to spray cut edges of frame to prevent rusting.
- Be sure that **ALL** electrical connections are plugged in and accessories are functioning properly before reinstalling the fascia.
- The baseplate is computer tested to your vehicle's GVWR, exceeding this weight will void the manufacturer's warranty.
- Be sure to use a sufficient amount of Loctite® Red on all bolt threads before tightening. Tighten all bolts according to the torque chart provided.
- Dealer or installer be certain the user receives these instruction sheets.
- If the baseplate is in an accident, it must be replaced. **DO NOT** use it again! An accident can cause unseen damage and using it again could result in more damage or serious injury. **DO NOT** use the baseplate if it is damaged or missing parts.

# BX2336

## 2013-2016 Hyundai Elantra GT/Sport

### Installation Instructions

#### Tools Required

Large Vise Grip  
 Flat Screwdriver  
 Utility Knife  
 Phillips Screwdriver  
 Torque Wrench  
 Drill  
 Reciprocating Saw  
 Tape Measure  
 Loctite® RED  
 13/32" Drill Bit  
 10MM Socket  
 12MM Socket  
 7/16" Socket  
 9/16" Socket  
 7/16" Wrench  
 9/16" Wrench

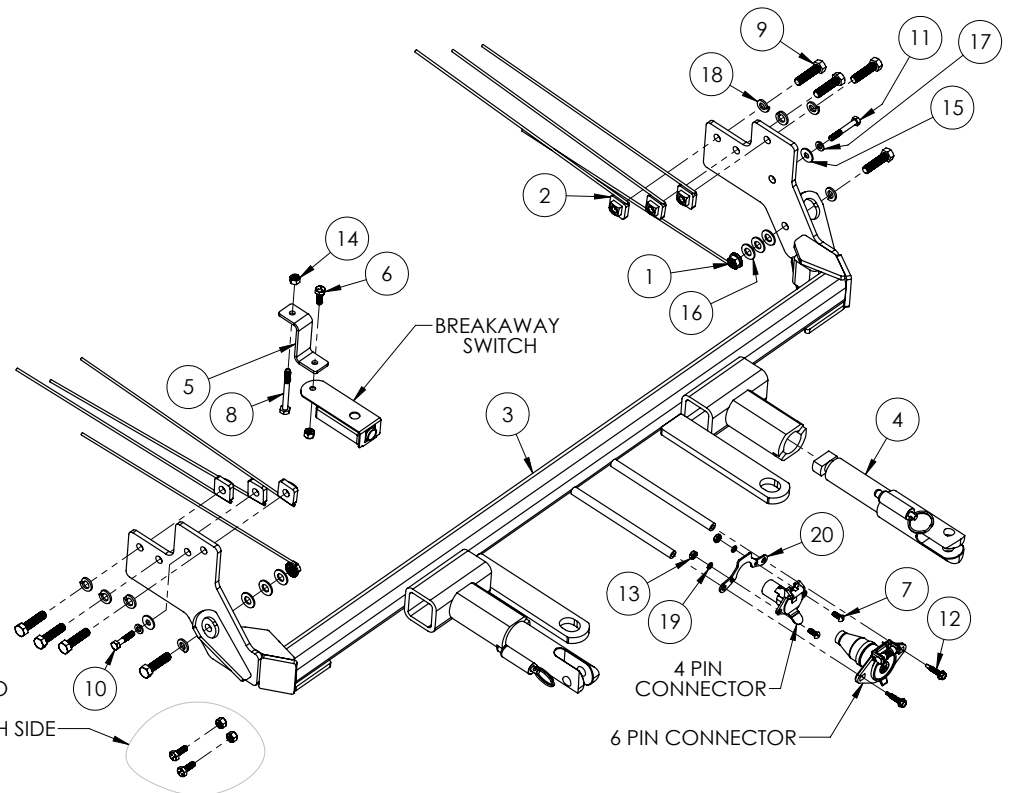

**NOTE:**  
 THESE ITEMS TO BE USED TO  
 RELOCATE THE HORNS  
 ONE BOLT & NUT ON EACH SIDE

Item No.	Part No.	Description	Qty.
1.....	61-4978 .....	3/8"-16 Whiz Nut w/ 14" Wire.....	2
2.....	61-5208 .....	3/8"-16 Nut Plate w/ 14" Wire .....	6
3.....	61-7124 .....	BX2336 Baseplate .....	1
4.....	62-3469 .....	Attachment Tab Assembly with Hole.....	2
5.....	102-7056 .....	BX2336 Breakaway Bracket.....	1
6.....	201-0050 .....	1/4"-20 x 3/4" Hex Head Bolt, Grade 5, ZP.....	3
7.....	201-0192 .....	#10-32 x 1/2" Round Slotted Head Screw .....	2
8.....	201-0321 .....	1/4"-20 x 2-1/2" Hex head Bolt, Grade 5, ZP .....	1
9.....	201-0440 .....	3/8"-16 x 1-1/2" Hex Head Bolt, Grade 5, ZP .....	8
10.....	201-0655 .....	6MM-1.0 x 30MM Hex Head Bolt, Grade 8.8, ZP .....	1
11.....	201-0702 .....	6MM-1.0 x 45MM Hex Head Bolt, Grade 8.8, ZP .....	1
12.....	201-0979 .....	#12-14 x 1" Self Drilling Screw, ZP .....	2
13.....	202-0047 .....	#10-32 Hex Nut.....	2
14.....	202-0102 .....	1/4"-20 Hex Nylon Nut, ZP.....	4
15.....	203-0001 .....	1/4" Flat Washer, ZP.....	2
16.....	203-0003 .....	3/8" Flat Washer, ZP.....	6
17.....	203-0008 .....	1/4" Lock Washer, ZP .....	2
18.....	203-0010 .....	3/8" Lock Washer, ZP .....	8
19.....	203-0054 .....	#10 Lock Washer, ZP.....	2
20.....	299-0685 .....	Electrical Bracket.....	1
21.....	226-0046(not shown) .....	Class III Safety Cables .....	2
22.....	229-0359(not shown) .....	3/8" Quicklink, ZP .....	2
23.....	290-0437(not shown) .....	Black Cap Plug Receiver .....	2

#### **Important:**

Use only genuine factory replacement parts on your baseplate. Do **NOT** substitute homemade or non-typical parts. If a bolt is lost or in need of replacement, for your safety and the preservation of your baseplate, be sure to use a replacement bolt of the same grade (In most cases it will be Grade 5, please reference the parts list above). Replacement parts may be ordered through your nearest Blue Ox® Dealer or Distributor. Failing to follow and/or altering these installation instructions in either installation or required equipment will void the manufacturer's warranty. Towing behind a non-motorized vehicle will void the warranty.



BX2336  
2013-2016 Hyundai Elantra GT/Sport  
Installation Instructions

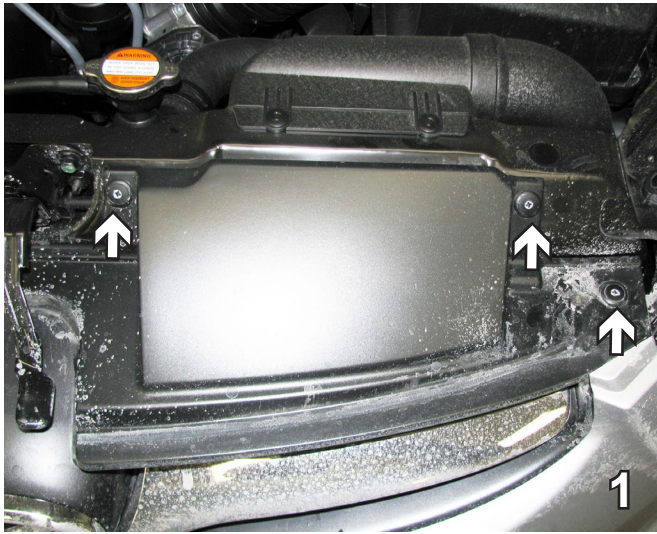

1. On the driver side using a Phillips screwdriver, remove three (3) push pins from the top of the fascia.

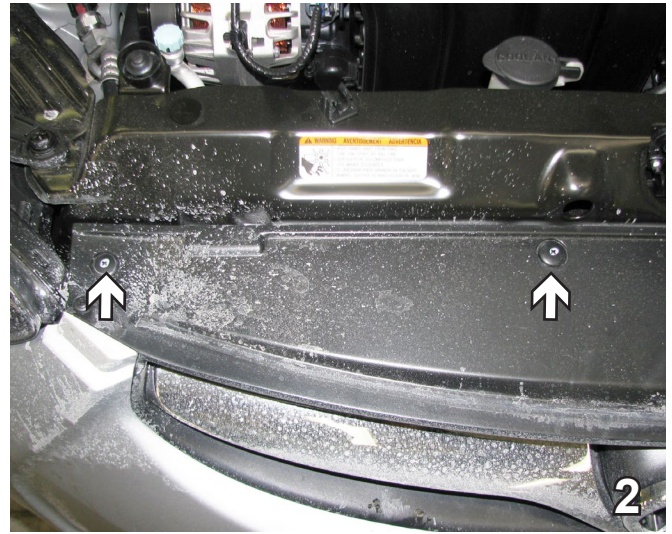

2. On the passenger side using a Phillips screwdriver, remove the two (2) push pins from the top of the fascia.



3. Using a 10MM socket, remove the metric bolt from in front of the tire. Do this to both sides of the vehicle.



4. Using a Phillips screwdriver, remove three (3) plastic Phillips push pins from just forward of the front tire along the bottom edge of fascia. Do this to both sides of the vehicle.

The fascia is then ready to be removed from the vehicle by pulling fascia ends out to the side to release and then pulling it forward.



BX2336  
2013-2016 Hyundai Elantra GT/Sport  
Installation Instructions



5. On the passenger side, unplug the hoses from the windshield washer reservoir and cap (gray arrows). Using a 10MM socket, remove the bolt on the side (white arrow).

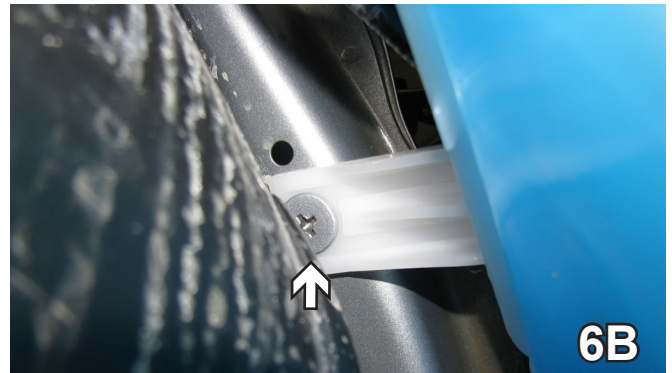
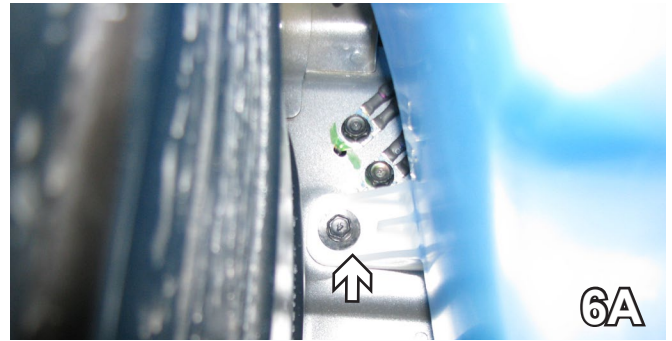

6. Using a 10MM socket, remove the metric bolt in the back (6A). Using a Phillips screwdriver loosen the screw on the top (6B).



7. Using a 10MM socket, remove two bolts underneath on the side of the back plastic cover. Do this on both sides of the vehicle.



8. Using a 10MM socket, remove the three (3) bolts underneath across the front of the back plastic cover. One bolt on each side and one in the middle.



BX2336  
2013-2016 Hyundai Elantra GT/Sport  
Installation Instructions

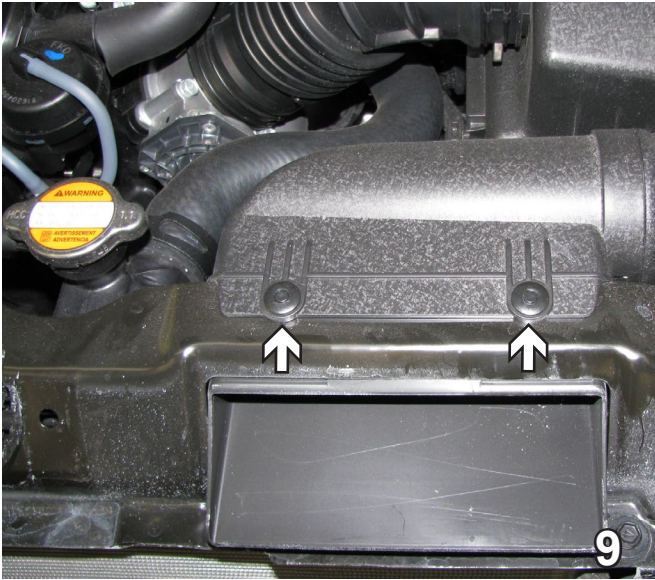

9. On the top front of the car, remove the two (2) push pins before the air baffle can be removed. Push in on each push pin and it will release and pop out.



10. On the driver side, using a 10MM socket remove the one (1) bolt on the outside of the air baffle.

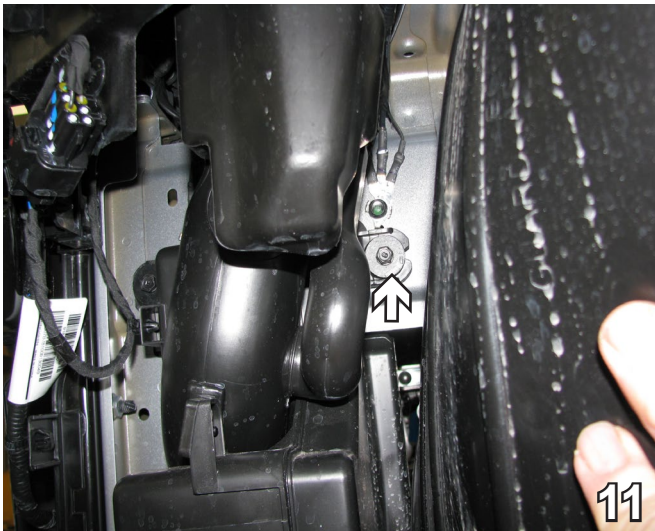

11. On the driver side, using a 10MM socket, remove the bolt from the back side of the air baffle.



12. On the driver side underneath the vehicle, using a 10MM socket remove the bolt.



BX2336  
2013-2016 Hyundai Elantra GT/Sport  
Installation Instructions

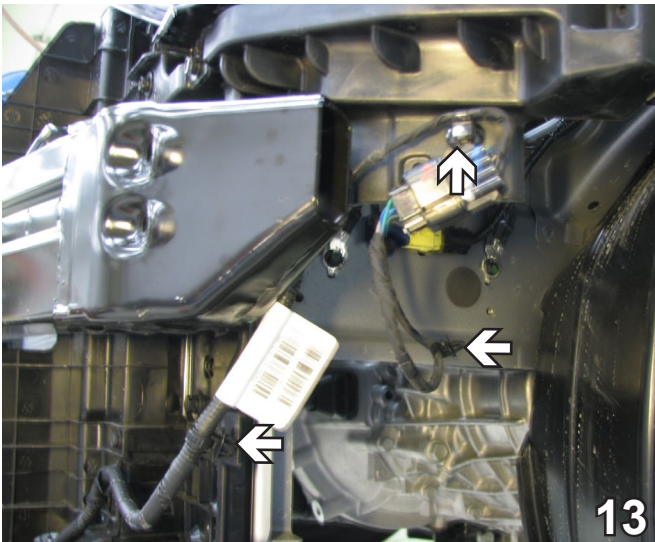

13. On the driver side, unplug the three (3) pins holding the cable and move it out of the way. It will be reattached later.

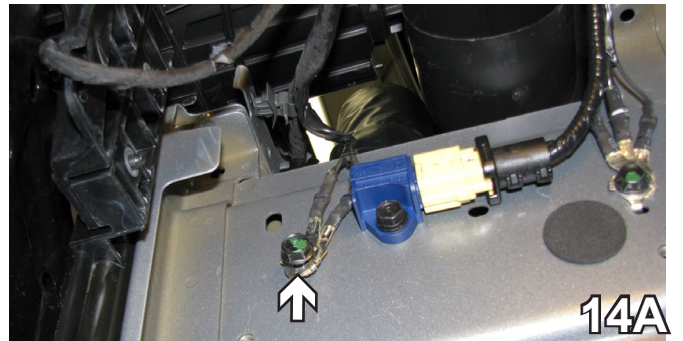

14. On the driver side, using a 10MM socket remove the ground wires from the left side and reattach them with the ground wires on the right side.

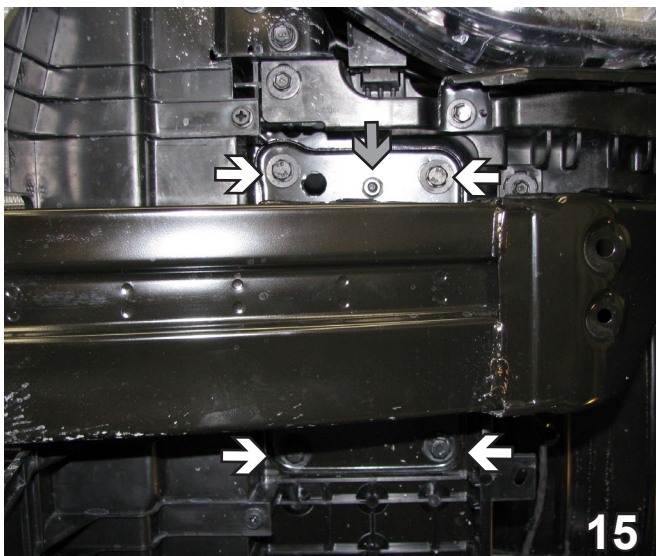

15. Using a 12MM socket, remove the two (2) bolts (white arrows) above and below the bumper. Using a 10MM socket, remove one (1) bolt (gray arrow) in the middle above the bumper. Do this to both sides of the vehicle.

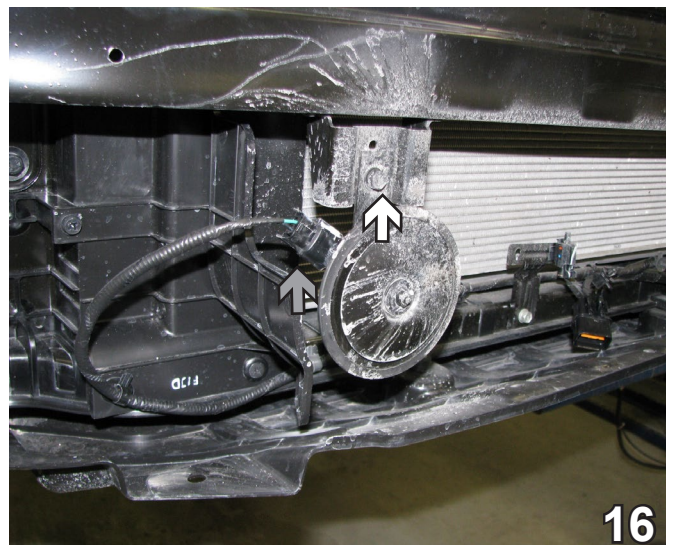

16. Using the 10MM socket, remove the bolt attaching the horn to the bracket (white arrow). Unplug the horn (gray arrow).



BX2336  
2013-2016 Hyundai Elantra GT/Sport  
Installation Instructions

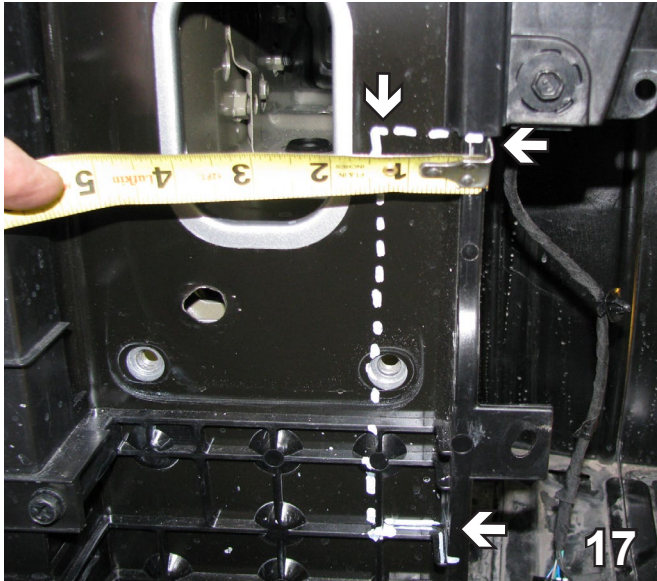

17. Using a reciprocating saw, trim out area below bumper. Measure just below metal bumper, in 1-1/2" from the side flush with the frame and straight down to the top of the second ridge. Remove this area from both sides.

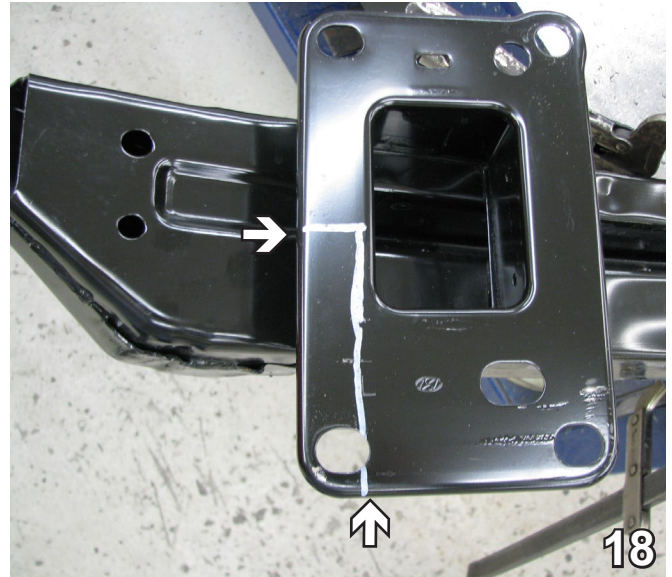

18. Put the bumper back on and mark on the backside of the bumper the area which was just removed. Using a reciprocating saw, trim out that area also. Do this to both sides of the bumper.

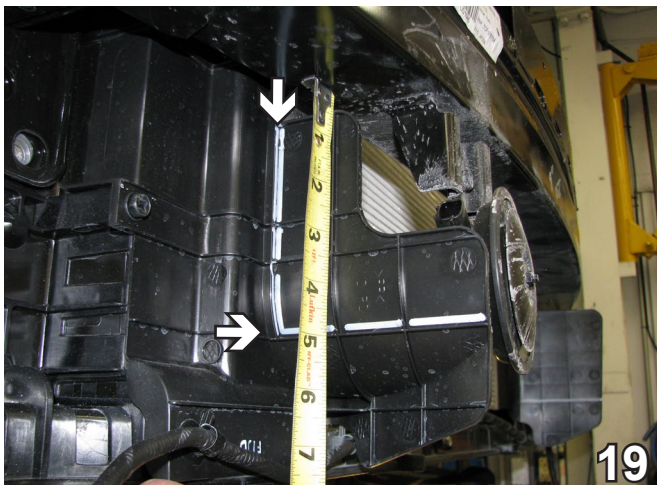

19. On the passenger side, cut the plastic 5" straight down and across along the ridge.

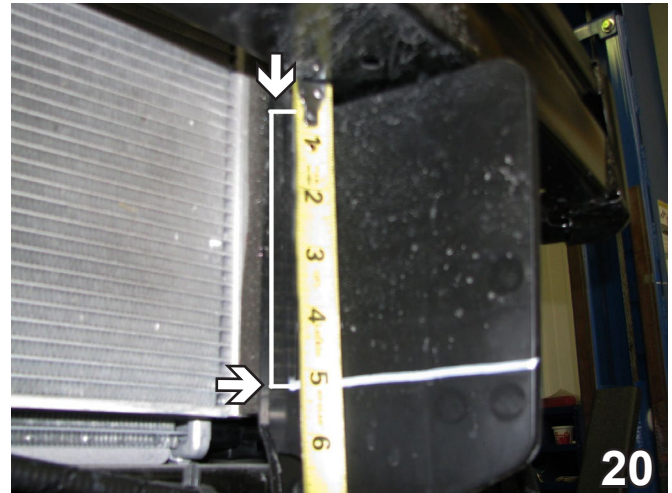

20. On the driver side, cut to the corner then 5" straight down to the bottom of the bumper and across.



BX2336  
2013-2016 Hyundai Elantra GT/Sport  
Installation Instructions



21. Cut the horn bracket off of the bumper on the passenger side. It will be reinstalled in a different location.

**Baseplate painted yellow for illustration.  
Actual baseplate will be powder-coat black.**

23. On the passenger side, start a bolt in the existing hole for the washer reservoir (gray arrow). Be sure the baseplate is level with respect to the vehicle frame. Tighten the bolt. Using the baseplate as a template with the 13/32" drill bit, drill the other four (4) holes (white arrows). Do this on both sides.



22. Slide the baseplate up so it aligns with the existing hole on the driver's side. Clamp into place with the large vise grips.

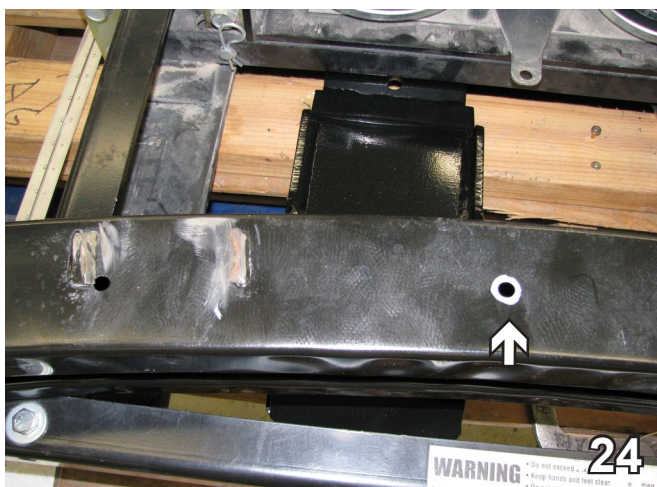
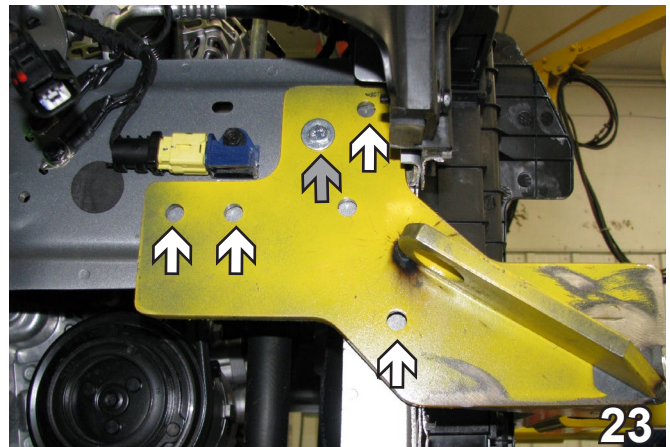

24. On the bottom of the bumper using a 13/32" drill bit, drill out the existing hole on the passenger side all the way through. This hole will be used later on for the breakaway bracket installation.

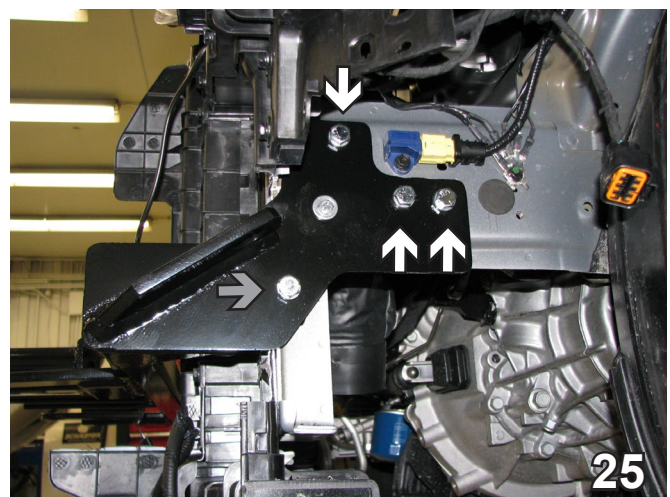

25. All four (4) bolts are 3/8"-16 x 1-1/2" and 3/8" lock washers. The top three (3) are attached to 1" nut plates inserted into the bumper opening. The bottom one is attached to a 3/8"-16 whiz nut inserted from underneath. Do this on both sides.



BX2336  
2013-2016 Hyundai Elantra GT/Sport  
Installation Instructions

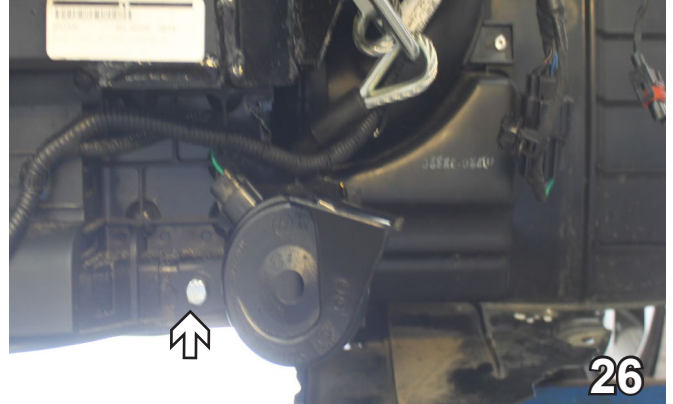
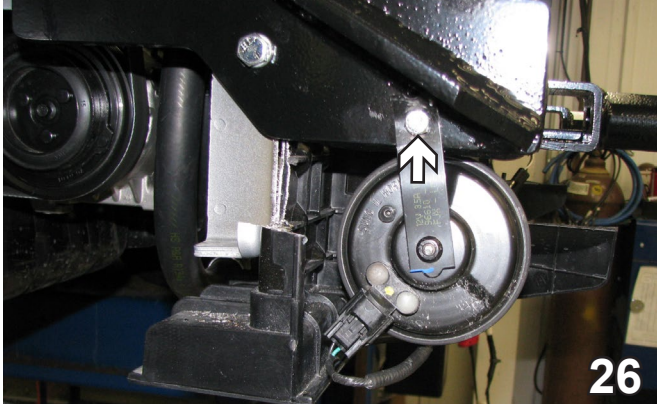

26. On the passenger side, mount the horn on the bottom baseplate hole with 1/4" hardware.

Models with two (2) horns will need to be relocated to the lower portion of the frame as shown (right) with the supplied 1/4" hardware. Do this on both sides of the vehicle.

Reinstall all electrical connections.

27. Reinstall the air baffle with a 6MM-1 x 45MM hex bolt, 1/4" lock washer and 1/4" flat washer on the outside. Reattach the other bolts.

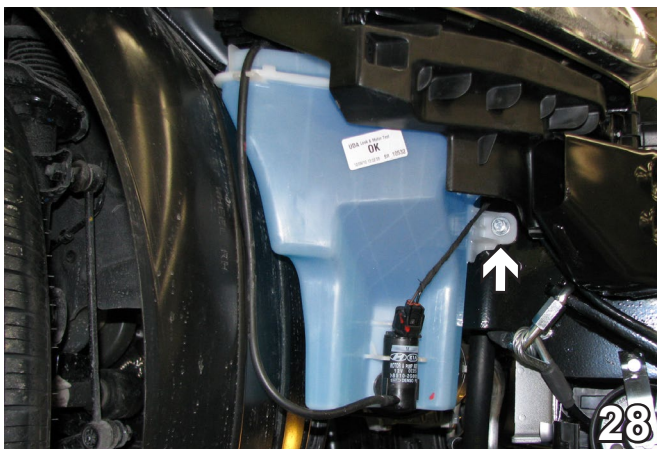

28. Reinstall the washer reservoir with a 6MM-1 x 30MM hex bolt, 1/4" lock washer and 1/4" flat washer into the existing hole on the baseplate. Use the existing bolts previously removed to tighten the other side. Reconnect the hoses.

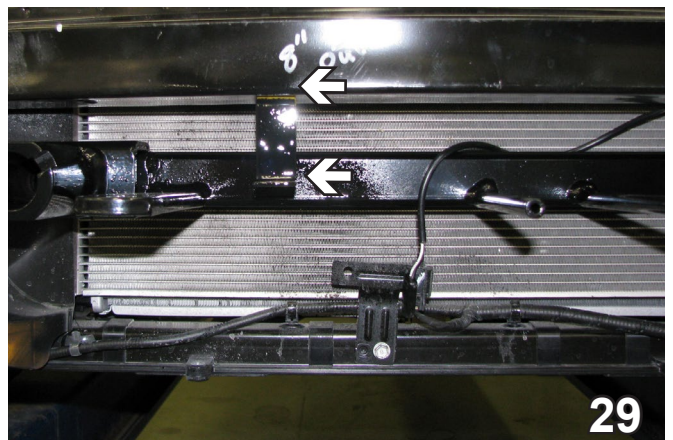

29. Using a 13/32" drill bit, drill through the existing hole in the bottom of the bumper. Attach the breakaway bracket with a 1/4"-20 x 2-1/2" hex bolt and 1/4"-20 hex nut. Attach the breakaway to the bracket with 1/4"-20 x 3/4" hex bolt and 1/4"-20 hex nut.



BX2336  
2013-2016 Hyundai Elantra GT/Sport  
Installation Instructions

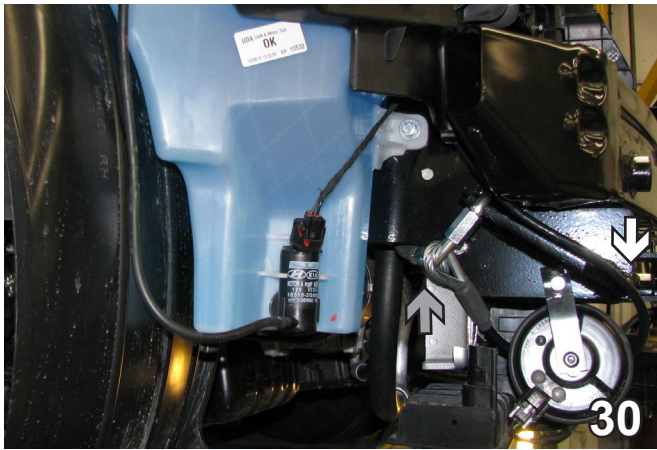

30. Attach the permanent baseplate safety cables to the provided convenience link on the baseplate (see grey arrow). The photo above shows the recommended installation of the cables to frame of vehicle (see white arrow). Additional options may interfere with suggested mounting; in this case secure the cables to a solid piece of the frame as described in the instructions included with the permanent baseplate safety cables. Be sure the safety cables do not rub against any hoses or moving parts. Do this to both sides of the vehicle.

31. Reinstall the bumper and plastic cover. Trim the fascia as needed to clear the baseplate attachment tabs then reinstall. Reconnect the cables and the electrical plugs.

## CUSTOMER SERVICE COMMITMENT

Blue Ox® is committed to providing you with exceptional customer care throughout your lifetime with our products. Our team is here to assist you with any questions you may have regarding the performance of your product. Simply call (402) 385-3051 and you can speak with our technical service team.

Additionally, please visit our website to see which rallies our Destination America team will be attending. For a nominal fee, our service technician will service your towing system to ensure it's in proper working condition. Also, as a commitment to our customers, should you visit our factory, you can stay at our full service Blue Ox® campground at no charge along with enjoying a factory tour.

Again, thank you for being our customer and for the confidence you have shown in the performance of our products. It is because of customers like you we enjoy the success we have today.

© 2015 Blue Ox  
One Mill Road, Industrial Park  
Pender, Nebraska 68047  
Phone: (402) 385-3051  
Fax: (402) 385-3360  
[www.blueox.com](http://www.blueox.com)

# General Information

1. Ensure that your product(s) are registered online at [www.blueox.com](http://www.blueox.com). It is crucial to register your product(s) so that you may be alerted of product offerings, updates, upgrades, maintenance and safety bulletins, and/or recalls.
2. **It is the owner's responsibility to inspect all towing equipment for cracked welds, missing or worn parts and loose bolts before each towing trip.** Be sure to use Loctite® Red on all bolts and tighten to the recommended specifications.
3. **It is the owner's responsibility to hook up all towing equipment per manufacturer's instructions/ recommendations.**
4. Remove the attachment tabs when not in use (if applicable).

## Notice To Baseplate Installer

### 1. It is YOUR responsibility to watch for:

- Oil cooler and air conditioner lines
- Electrical wires and hoses
- Missing parts or attaching points on the frame

\*\* If the baseplate is improperly installed and is against a wire or hose, it could cause fluid leaks or electrical shorts some time after the actual baseplate installation.

## Permanent Baseplate Safety Cable Installation

Permanent baseplate safety cables are strongly recommended when towing a vehicle with a tow bar. The principle function of the permanent baseplate safety cables is to prevent the towed vehicle from breaking loose in the event the connection between the frame of the towed vehicle and the baseplate fails or becomes disconnected. The cables must be connected from the baseplate to the frame rail or cross member of the vehicle's frame. The illustrations below show the possible arrangements recommended by Blue Ox®. Each permanent baseplate safety cable must have an adequate weight rating for the towing system. The weight rating of the two (2) cables together will not qualify.

***Do not mount the permanent baseplate safety cables against wires, hoses or brake lines.***

These permanent baseplate safety cables should remain installed as long as the baseplate is installed on the vehicle. Permanent baseplate safety cables are to be used in conjunction with, and NOT a replacement for legally required safety cables attaching the towed vehicle to the towing vehicle.

### OPTION #1

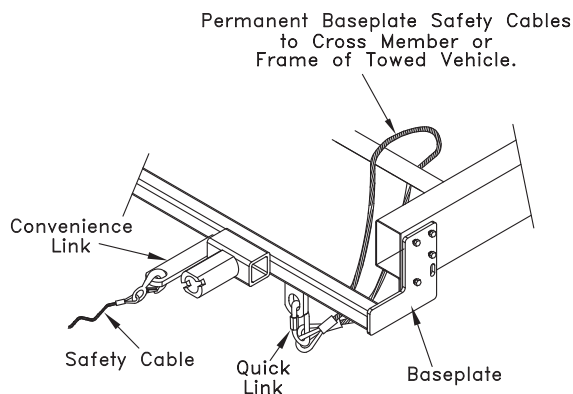

### OPTION #2

