



BX1843

2005-2019 Nissan Frontier (Manual) 2005 Nissan Pathfinder LE/SE/XE 2008-2012 Nissan Pathfinder Installation Instructions

Please read **BOTH** these Installation Instructions and the General Information sheet prior to installing or operating this equipment.

Serial Number

Attachment Tab Height: 12-1/2"

Attachment Tab Width: 33-1/2"

Please ensure tow bar being used is compatible with the baseplate tab width.

- Blue Ox® towing products and accessories are intended to be installed by Blue Ox® Dealers who are familiar with our products and have the equipment and knowledge necessary to do "fit work". If needed, Blue Ox® Dealers can be found at www.blueox.com or by contacting our Technical Service Department at (402) 385-3051.
- Many Blue Ox® baseplates are designed to use existing holes and hardware to mount the baseplate to the towed vehicle. Even though bolts are there, do not assume they are adequate for baseplate mounting. Always use the hardware supplied in the hardware kit and existing hardware as specified in the installation instructions.

Bolt Torque Specifications

Torque in Foot-Pounds for Inch Bolts

Bolt Size	Grade 5	Grade 8
1/4"	10	14
5/16"	19	29
3/8"	33	47
7/16"	54	78
1/2"	78	119
5/8"	154	230
3/4"	257	380

Bolt Torque Specifications

Torque in Foot-Pounds for Metric Bolts

Bolt Size	Grade 8.8	Grade 10.9
6MM	6	8
8MM	16	22
10MM	31	40
12MM	54	70
14MM	89	117
16MM	161	230
18MM	222	318



If the front of your vehicle looks different than this, please contact us at (402)385-3051.

Reference your vehicle owner's manual for manufacturer's towing specifications.



WARNING

Failure to read and follow these instructions could result in separation of the towed vehicle from the tow bar, causing property damage, loss of towed vehicle, personal injury or death.

BX1843
2005-2019 Nissan Frontier (Manual)
2005 Nissan Pathfinder LE/SE/XE
2008-2012 Nissan Pathfinder

Instruction Notes: The grille, fascia and bumper are removed and reinstalled for the baseplate installation. Some drilling and trimming is required.

Place all components that are removed on a flat, sturdy surface. All items will be reinstalled unless otherwise noted after the baseplate is installed.

The dimensional variations between otherwise identical vehicles can be considerable. While the baseplate was designed for easy installation, it may be necessary to tailor the baseplate slightly to compensate for vehicle manufacturer's tolerances.

The BX8869 Tail Light Wiring Kit is recommended for this vehicle.



Drill a hole according to the tail light wiring kit instructions.

NOTICE

- Handling of some cosmetic parts when installing this product may require the use of protective covers, rags, specialty tools, etc. to prevent damage.
- When using power drills be aware of the dangers of torque and drill bit length.
- When using a reciprocating saw be aware of objects behind the cutting surface.
- Use a good quality paint to spray cut edges of frame to prevent rusting.
- Be sure that **ALL** electrical connections are plugged in and accessories are functioning properly before reinstalling the fascia.
- The baseplate is computer tested to your vehicle's GVWR, exceeding this weight will void the manufacturer's warranty.
- Be sure to use a sufficient amount of Loctite® Red on all bolt threads before tightening. Tighten all bolts according to the torque chart provided.
- Dealer or installer be certain the user receives these instruction sheets.
- If the baseplate is in an accident, it must be replaced. **DO NOT** use it again! An accident can cause unseen damage and using it again could result in more damage or serious injury. **DO NOT** use the baseplate if it is damaged or missing parts.

BX1843
 2005-2019 Nissan Frontier (Manual)
 2005 Nissan Pathfinder LE/SE/XE
 2008-2012 Nissan Pathfinder

Tools Required

Large Vise Grip
 Flat Screwdriver
 Utility Knife
 Phillips Screwdriver
 Torque Wrench
 Drill
 Tape Measure
 Loctite® RED
 17/32" Drill Bit
 1-1/4" Hole Saw
 10MM Socket
 17MM Socket
 19MM Socket
 7/16" Socket
 3/4" Socket
 5/16" Nut Driver

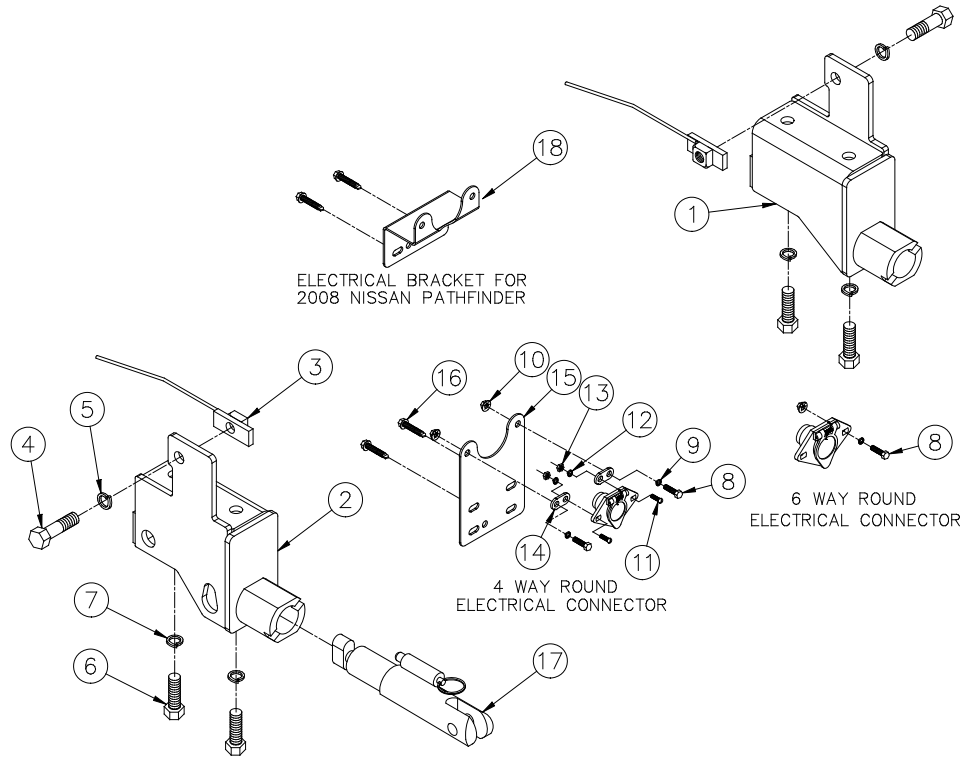

Item No.	Part No.	Description	Qty.
1.....	61-6130.....	BX1843 Baseplate, DS.....	1
2.....	61-6131.....	BX1843 Baseplate, PS.....	1
3.....	61-3799.....	1/2"-13 Nut Plate, w/10" Wire.....	2
4.....	201-0051.....	1/2"-13 x 1-1/2" Hex Head Bolt, Grade 5, ZP.....	2
5.....	203-0012.....	1/2" Lock Washer, ZP.....	2
6.....	201-0411.....	12MM-1.25 x 40MM Hex Head Bolt, Grade 8.8, ZP.....	4
7.....	203-0105.....	12MM Lock Washer, ZP.....	4
8.....	201-0050.....	1/4"-20 x 3/4" Hex Head Bolt, Grade 5, ZP.....	2
9.....	203-0008.....	1/4" Lock Washer, ZP.....	2
10.....	202-0069.....	1/4"-20 Hex Flange Whiz Lock Nut, ZP.....	2
11.....	201-0192.....	#10-32 x 1/2" Round Slot Head Screw.....	2
12.....	203-0054.....	#10 Lock Washer.....	2
13.....	202-0047.....	#10-32 Hex Nut.....	2
14.....	101-5822.....	4 Way Connector Adapter.....	2
15.....	101-6739.....	BX2908 Electrical Bracket.....	1
16.....	201-0654.....	#10-16 x 1" Self Drilling Screw, ZP.....	2
17.....	62-3468.....	Attachment Assembly, SF/SB (R).....	2
18.....	101-7202.....	BX1843 Electrical Bracket.....	1
19.....	102-7186(not shown).....	Breakaway Bracket.....	1
20.....	226-0046(not shown).....	Class III Safety Cables.....	2
21.....	229-0359(not shown).....	3/8" Quicklink, ZP.....	2
22.....	290-0437(not shown).....	Black Cap Plug Receiver.....	2

Important:

Use only genuine factory replacement parts on your baseplate. Do **NOT** substitute homemade or non-typical parts. If a bolt is lost or in need of replacement, for your safety and the preservation of your baseplate, be sure to use a replacement bolt of the same grade (In most cases it will be Grade 5, please reference the parts list above). Replacement parts may be ordered through your nearest Blue Ox® Dealer or Distributor. Failing to follow and/or altering these installation instructions in either installation or required equipment will void the manufacturer's warranty. Towing behind a non-motorized vehicle will void the warranty.

BX1843
2005-2019 Nissan Frontier (Manual)
2005 Nissan Pathfinder LE/SE/XE
2008-2012 Nissan Pathfinder

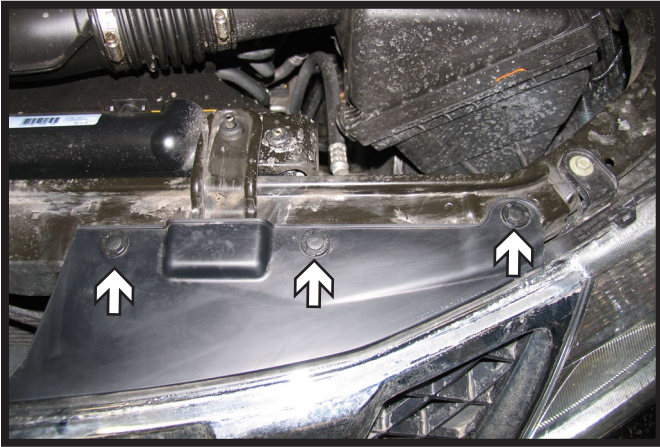

1. Remove three (3) push pins from the top of the grille. Do this on both sides.

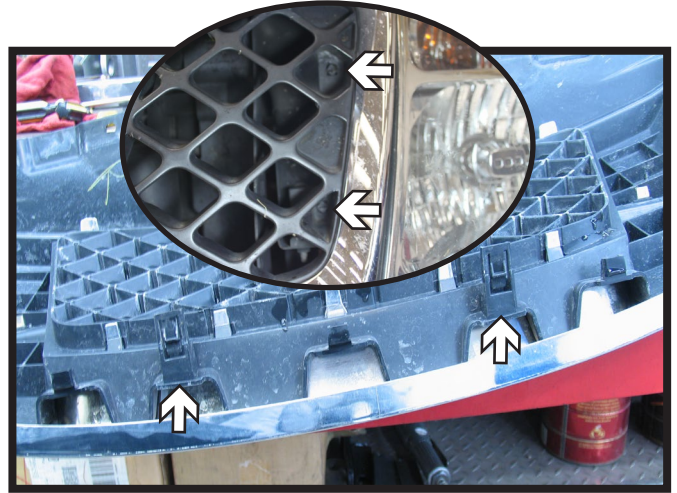

2. **2011 & Older Models:** To remove the grille, turn the two (2) square pins (inset). Then reach in and push up on the two (2) clips. Do this on both sides and remove the grille.

2012 & Newer Models: To remove the grille, reach under the grille and push up on the six (6) clips. There are three (3) on each side and remove the grille.

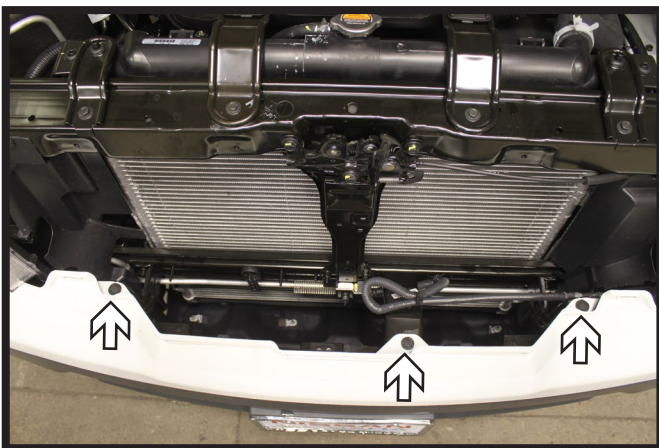

3. Remove three (3) push pins from the top of the fascia.

BX1843
2005-2019 Nissan Frontier (Manual)
2005 Nissan Pathfinder LE/SE/XE
2008-2012 Nissan Pathfinder

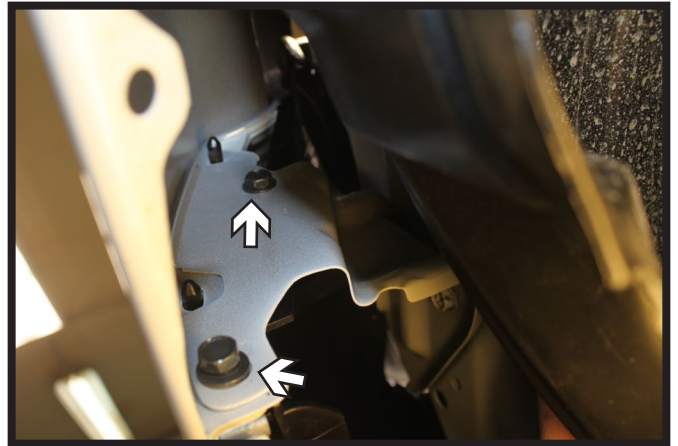
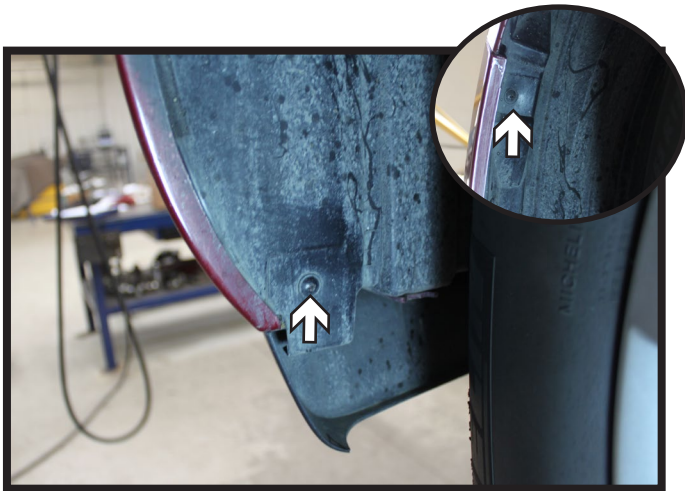

4. In the wheel well, using a Phillips screwdriver, remove the lower and upper screws. Do this to both sides of the vehicle.

Note: On newer models behind the wheel well cover, using a 10MM socket, remove the screws from the fender/fascia joint. Do this on both sides of the vehicle.

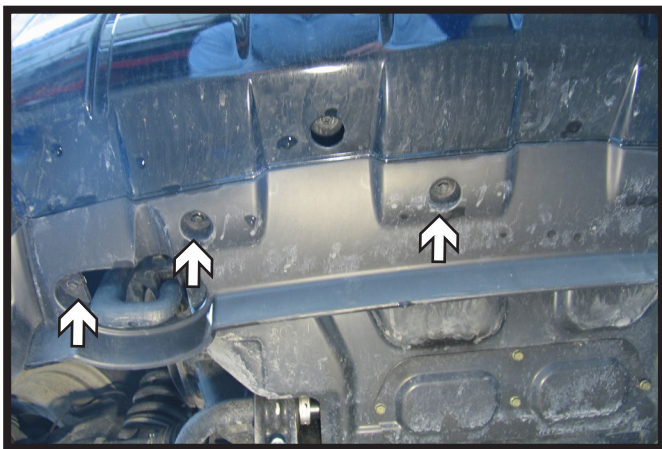

5. On the underside of the fascia, using a 10MM socket, remove the six (6) screws from the shrouding. There are three (3) on each side. Set the shroud aside.

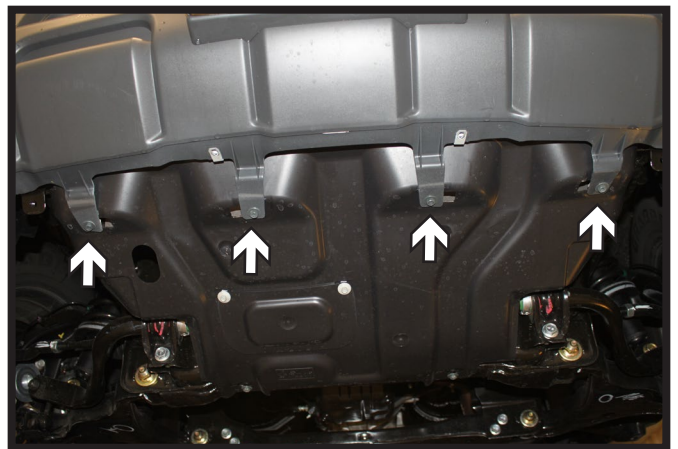

6. Using a 10MM socket, remove the four (4) screws from the underside of the fascia.

BX1843
2005-2019 Nissan Frontier (Manual)
2005 Nissan Pathfinder LE/SE/XE
2008-2012 Nissan Pathfinder

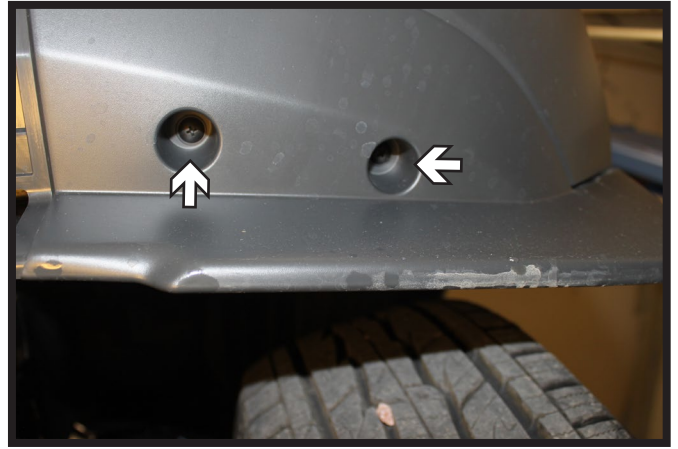

7. **Older Models:** On the back side of the rubber cover in front of the tire, remove the two (2) screws using a Phillips screwdriver. Do this on both sides. (Left)
- Newer Models:** On the underside of the fascia, remove the two (2) screws using a Phillips screwdriver. Do this on both sides. (Right)

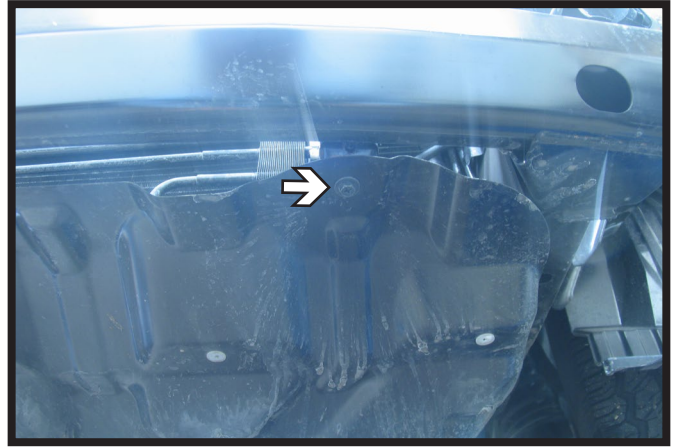
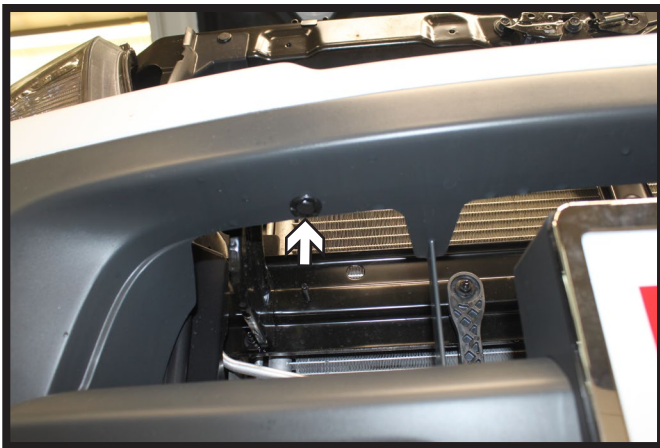

8. On the top side of the lower grille opening remove the three (3) push pins.
Pull the corners of the fascia away from the vehicle disconnecting any electrical connections and set the fascia aside.
9. Using the 10MM socket, remove the two (2) bolts from the belly pan that bolt into the bottom of the metal bumper.

BX1843
2005-2019 Nissan Frontier (Manual)
2005 Nissan Pathfinder LE/SE/XE
2008-2012 Nissan Pathfinder

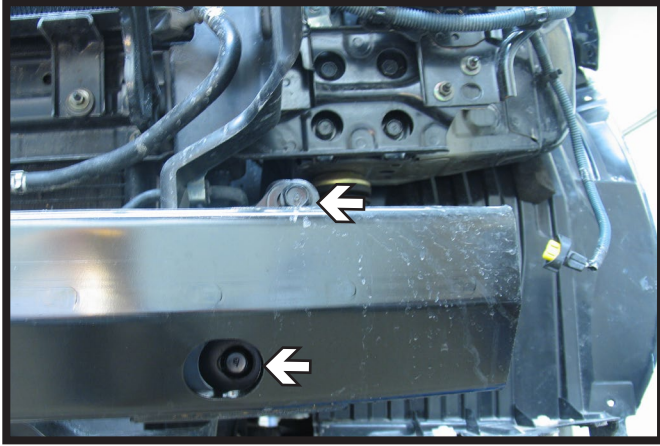

10. Remove the two (2) bolts from the metal bumper with a 17MM socket. Do this on both sides.

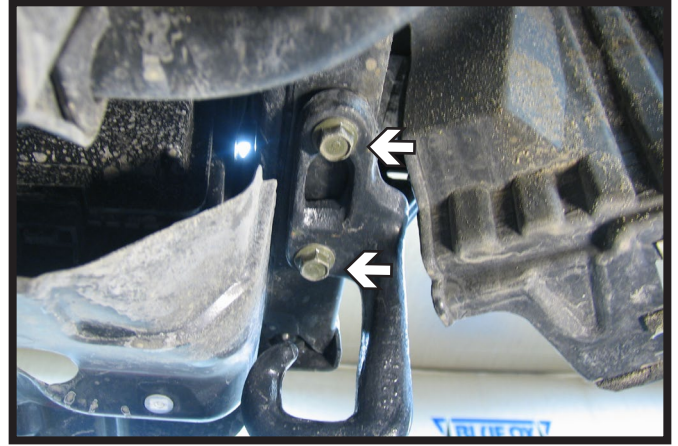

11. Remove the two (2) bolts from the tow hook on the passenger's side only using a 17MM socket. **The tow hook will NOT be reinstalled.**

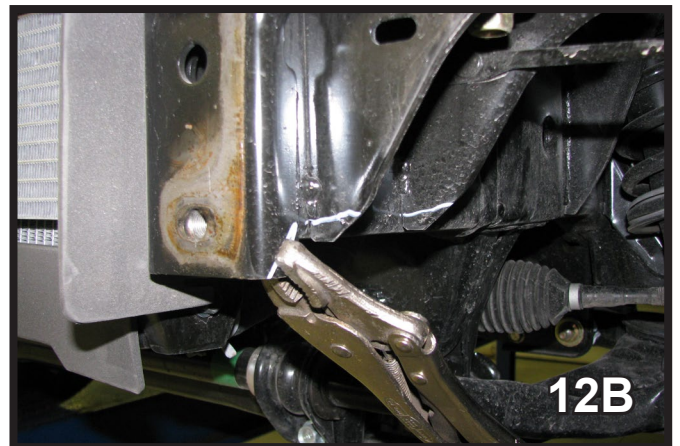
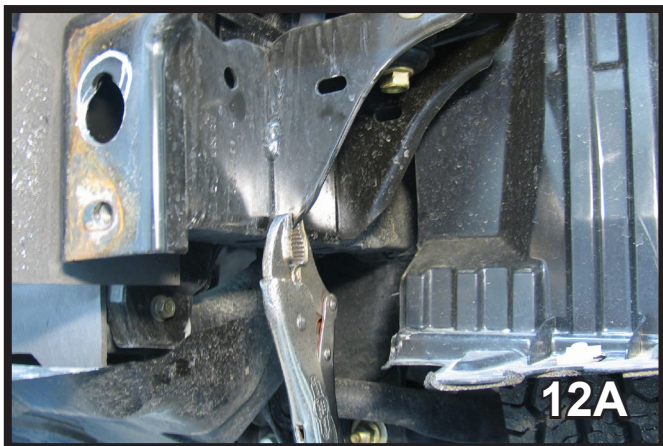

12. Using the vise grip bend the frame support, approximately 1/2" up from the bottom, back and fourth until it snaps off on both the front and back supports. Do this on both sides. (14A)
On 2011-12 Models: In addition to front and back supports, snap off the area in front of the supports for additional baseplate clearance. Do this on both sides. (14B)

Align the baseplate on the passenger's side with the existing holes for the tow hook, tighten the 12MM-1.25 hex bolts and 12MM lock washers into existing holes. Install baseplate in the same location on the driver's side

BX1843
2005-2019 Nissan Frontier (Manual)
2005 Nissan Pathfinder LE/SE/XE
2008-2012 Nissan Pathfinder

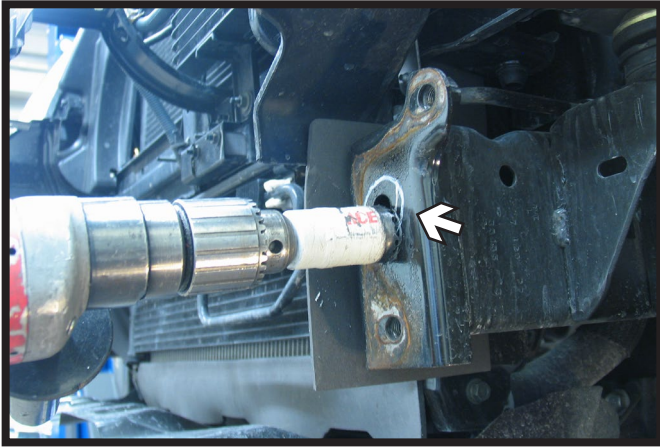

13. Using a 1-1/4" hole saw, drill a hole as shown in the driver's side frame that is connected with the existing hole for nut plate access.

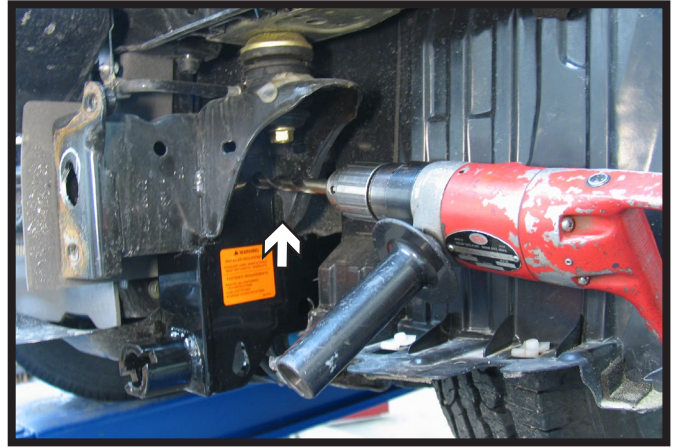

14. Using the baseplate as a template, drill a hole into the side of the frame rail with the 17/32" drill bit. Do this on both sides.

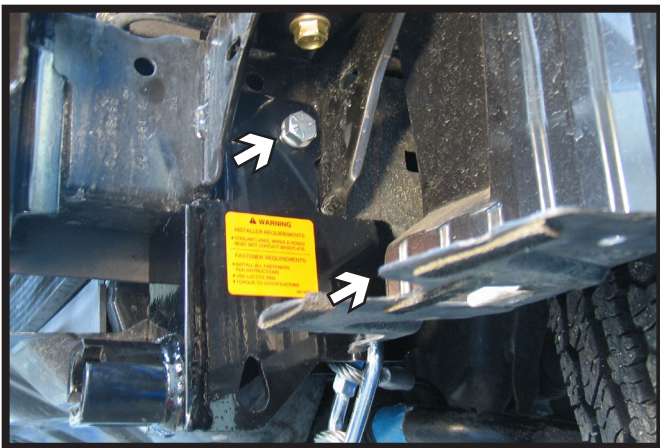

15. Insert the nut plate into the drilled hole on the frame cap to align with the drilled hole, tighten the 1/2"-13 hex bolt and 1/2" lock washer into the drilled hole. Repeat on other side.

**** Use Loctite® Red on all bolt threads and tighten all bolts to the appropriate torque. ****



16. Attach the permanent baseplate safety cables to the provided convenience link on the baseplate. The photo above shows the recommended installation of the cables to frame of vehicle. Additional options may interfere with suggested mounting; in this case, secure the cables to a solid piece of the frame as described in the General Information sheet. Be sure the safety cables do not rub against any hoses or moving parts. Do this on **BOTH** sides of the vehicle.

BX1843
 2005-2019 Nissan Frontier (Manual)
 2005 Nissan Pathfinder LE/SE/XE
 2008-2012 Nissan Pathfinder

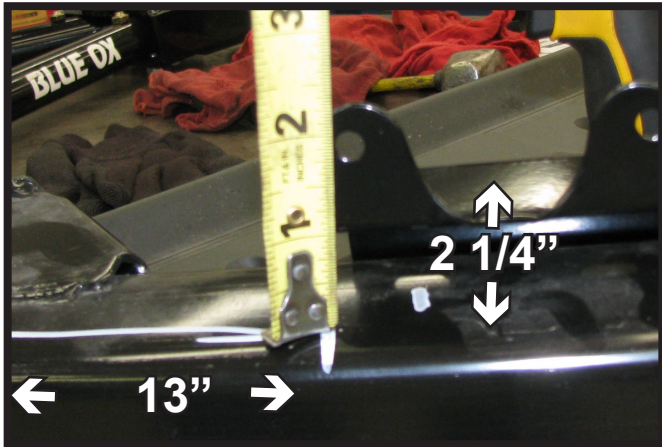

17. Set the metal bumper on a bench, clamp the electrical bracket to the back of the driver's side with the vise grip. The bracket should measure 13" from the driver's end of the metal bumper and 2-1/4" from the top edge of the bumper to the top hole location. Attach the bracket with the two (2) #10-16 self drilling screws using the 5/16" nut driver. Reinstall the metal bumper with the existing bolts.
 Reinstall the fascia.

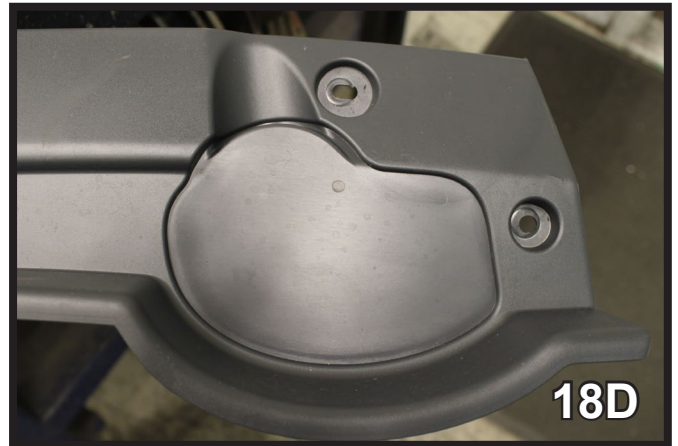
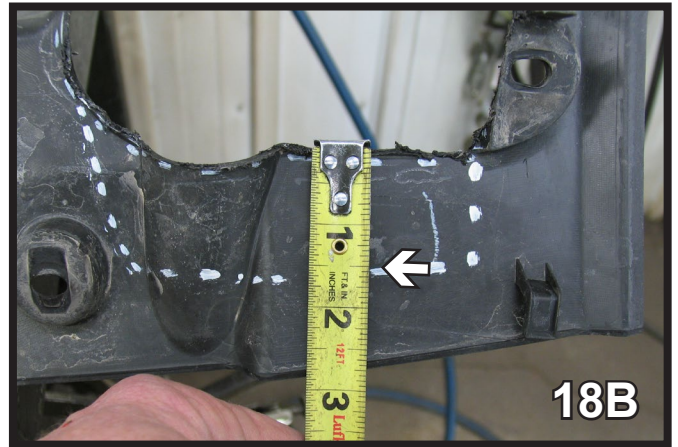

19. **Older models:** Trim the lower fascia piece where the tow hooks come through, on the driver's side cut the lip and the whole circle out like on the passenger side (18A). Continue to trim an additional 1-1/2" straight down and next to the opening (18B).

Newer Models: On the driver side of the shroud (18D), trim out the recessed area to match the passenger side (18C).

Reinstall the shroud.

BX1843
2005-2019 Nissan Frontier (Manual)
2005 Nissan Pathfinder LE/SE/XE
2008-2012 Nissan Pathfinder



20. Reinstall the grille.

CUSTOMER SERVICE COMMITMENT

Blue Ox® is committed to providing you with exceptional customer care throughout your lifetime with our products. Our team is here to assist you with any questions you may have regarding the performance of your product. Simply call (402) 385-3051 and you can speak with our technical service team.

Additionally, please visit our website to see which rallies our Destination America team will be attending. For a nominal fee, our service technician will service your towing system to ensure it's in proper working condition. Also, as a commitment to our customers, should you visit our factory, you can stay at our full service Blue Ox® campground at no charge along with enjoying a factory tour.

Again, thank you for being our customer and for the confidence you have shown in the performance of our products. It is because of customers like you we enjoy the success we have today.

© 2022 Blue Ox
One Mill Road, Industrial Park
Pender, Nebraska 68047
Phone: (402) 385-3051
Fax: (402) 385-3360
www.blueox.com

General Information

1. Ensure that your product(s) are registered online at www.blueox.com. It is crucial to register your product(s) so that you may be alerted of product offerings, updates, upgrades, maintenance and safety bulletins, and/or recalls.
2. **It is the owner's responsibility to inspect all towing equipment for cracked welds, missing or worn parts and loose bolts before each towing trip.** Be sure to use Loctite® Red on all bolts and tighten to the recommended specifications.
3. **It is the owner's responsibility to hook up all towing equipment per manufacturer's instructions/recommendations.**
4. Remove the attachment tabs when not in use (if applicable).

Notice To Baseplate Installer

1. It is YOUR responsibility to watch for:

- Oil cooler and air conditioner lines
- Electrical wires and hoses
- Missing parts or attaching points on the frame

** If the baseplate is improperly installed and is against a wire or hose, it could cause fluid leaks or electrical shorts some time after the actual baseplate installation.

Permanent Baseplate Safety Cable Installation

Permanent baseplate safety cables are strongly recommended when towing a vehicle with a tow bar. The principle function of the permanent baseplate safety cables is to prevent the towed vehicle from breaking loose in the event the connection between the frame of the towed vehicle and the baseplate fails or becomes disconnected. The cables must be connected from the baseplate to the frame rail or cross member of the vehicle's frame. The illustrations below show the possible arrangements recommended by Blue Ox®. Each permanent baseplate safety cable must have an adequate weight rating for the towing system. The weight rating of the two (2) cables together will not qualify.

Do not mount the permanent baseplate safety cables against wires, hoses or brake lines.

These permanent baseplate safety cables should remain installed as long as the baseplate is installed on the vehicle. Permanent baseplate safety cables are to be used in conjunction with, and NOT a replacement for legally required safety cables attaching the towed vehicle to the towing vehicle.

OPTION #1



OPTION #2

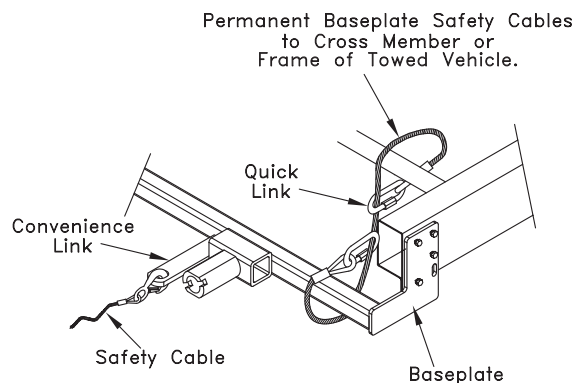

BLUE OX ORIGINAL PURCHASERS THREE YEAR LIMITED WARRANTY

Automatic Equipment Manufacturing Company ("Automatic") warrants to the original (first) retail purchaser that this product, manufactured by Automatic, shall be free from defect in material and workmanship under normal use and service for a period of three years from the date of delivery.

During said three-year period, Automatic will repair or replace any parts that have been returned by the original purchaser, to the factory, transportation prepaid, and in Automatic's sole and absolute opinion found to be defective.

Limitations on Warranty Coverage:

Coverage under this warranty will be valid only if the customer warranty card is returned by the original purchaser within 30 days of purchase.

Coverage under this warranty will be effective only when a copy of the original invoice, showing date and place of purchase, accompanies any claim for warranty. This warranty is NON TRANSFERABLE.

This limited warranty will not cover, in any way or form, any alleged damages caused by incorrect or improper installation, improper use, modification or neglect of product, failure to properly service and maintain, misuse, act of God, accident or failure of the user to follow guidelines contained in the instructional material provided by Automatic.

This warranty does not cover normal wear and tear, paint or rust.

Warrantor assumes no responsibility to the owner for loss of use of product, loss of time, inconvenience or any other damage consequential or otherwise. Including, but not limited to mileage, expense of transporting of product, return shipping expense, mechanics travel time, telephone, road service, towing, and rental during repairs, travel, lodging, loss or damage to personal property or loss of earnings.

REPAIR OR REPLACEMENT AS SET FORTH IN THIS LIMITED WARRANTY IS THE SOLE EXCLUSIVE REMEDY OF THE PURCHASER. AUTOMATIC SHALL NOT BE LIABLE FOR ANY INCIDENTAL OR CONSEQUENTIAL DAMAGES FOR BREACH OF ANY EXPRESS OR IMPLIED WARRANTY ON THIS PRODUCT. EXCEPT TO THE EXTENT PROHIBITED BY APPLICABLE LAW, ANY IMPLIED WARRANTY OF MERCHANTABILITY OR FITNESS FOR A PARTICULAR PURPOSE ON THIS PRODUCT IS LIMITED IN LENGTH TO THE DURATION OF THIS WARRANTY.

Please visit <http://blueox.com/warranty/> to register your warranty



BLUE OX