



BX1144

2019-2023 Jeep Cherokee Aluminum Bumper w/out Tow Hooks
 (Includes Adaptive Cruise Control, Shuttters, & Technology Package)
 (2-Speed Transfer Case)
 Installation Instructions

Please read BOTH these Installation Instructions and the General Information sheet prior to installing or operating this equipment.

1. Blue Ox® towing products and accessories are intended to be installed by Blue Ox® Dealers who are familiar with our products and have the equipment and knowledge necessary to do “fit work”. If needed, Blue Ox® Dealers can be found at www.blueox.com or by contacting our Technical Service Department at (402) 385-3051.
2. Many Blue Ox® baseplates are designed to use existing holes and hardware to mount the baseplate to the towed vehicle. Even though bolts are there, do not assume they are adequate for baseplate mounting. Always use the hardware supplied in the hardware kit and existing hardware as specified in the installation instructions.

Serial Number

Attachment Tab Height: 19”

Attachment Tab Width: 38”

Please ensure tow bar being used is compatible with the baseplate tab width.



If the front of your vehicle looks different than this, please contact us at (402)385-3051.

Bolt Torque Specifications		
Torque in Foot-Pounds for Inch Bolts		
Bolt Size	Grade 5	Grade 8
1/4"	10	14
5/16"	19	29
3/8"	33	47
7/16"	54	78
1/2"	78	119
5/8"	154	230
3/4"	257	380

Bolt Torque Specifications		
Torque in Foot-Pounds for Metric Bolts		
Bolt Size	Grade 8.8	Grade 10.9
6MM	6	8
8MM	16	22
10MM	31	40
12MM	54	70
14MM	89	117
16MM	161	230
18MM	222	318

WARNING

Failure to read and follow these instructions could result in separation of the towed vehicle from the tow bar, causing property damage, loss of towed vehicle, personal injury or death.

BX1144

2019-2023 Jeep Cherokee Aluminium Bumper w/out Tow Hooks (Includes Adaptive Cruise Control, Shuttters, & Technology Package) (2-Speed Transfer Case) Installation Instructions

Reference your vehicle owner's manual for manufacturer's towing specifications.

Instruction Notes: The fascia and fascia cover are removed and reinstalled for the baseplate installation. Some trimming is required.

Place all components that are removed on a flat, sturdy surface. All items will be reinstalled unless otherwise noted after the baseplate is installed.

The dimensional variations between otherwise identical vehicles can be considerable. While the baseplate was designed for easy installation, it may be necessary to tailor the baseplate slightly to compensate for vehicle manufacturer's tolerances.

The BX8848 Tail Light Wiring Kit is recommended for this vehicle.

NOTICE

- Handling of some cosmetic parts when installing this product may require the use of protective covers, rags, specialty tools, etc. to prevent damage.
- When using power drills be aware of the dangers of torque and drill bit length.
- When using a reciprocating saw be aware of objects behind the cutting surface.
- Use a good quality paint to spray cut edges of frame to prevent rusting.
- Be sure that **ALL** electrical connections are plugged in and accessories are functioning properly before reinstalling the fascia.
- The baseplate is computer tested to your vehicle's GVWR, exceeding this weight will void the manufacturer's warranty.
- Be sure to use a sufficient amount of Loctite® Red on all bolt threads before tightening. Tighten all bolts according to the torque chart provided unless specified.
- Dealer or installer be certain the user receives these instruction sheets.
- If the baseplate is in an accident, it must be replaced. **DO NOT** use it again! An accident can cause unseen damage and using it again could result in more damage or serious injury. **DO NOT** use the baseplate if it is damaged or missing parts.

BX1144

2019-2023 Jeep Cherokee Aluminium Bumper w/out Tow Hooks
(Includes Adaptive Cruise Control, Shuttters, & Technology Package) (2-Speed Transfer Case)

Installation Instructions

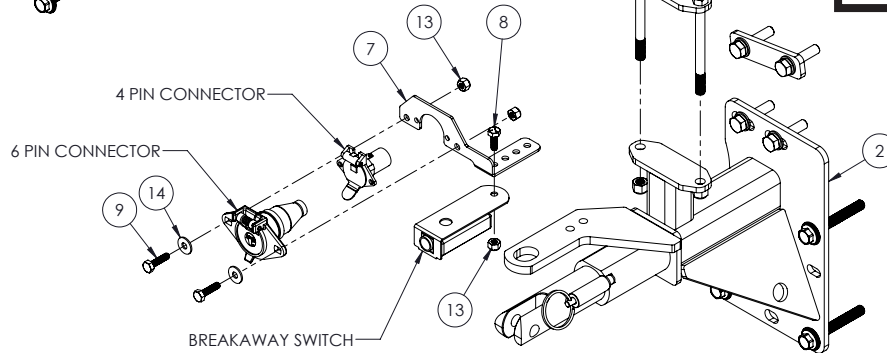
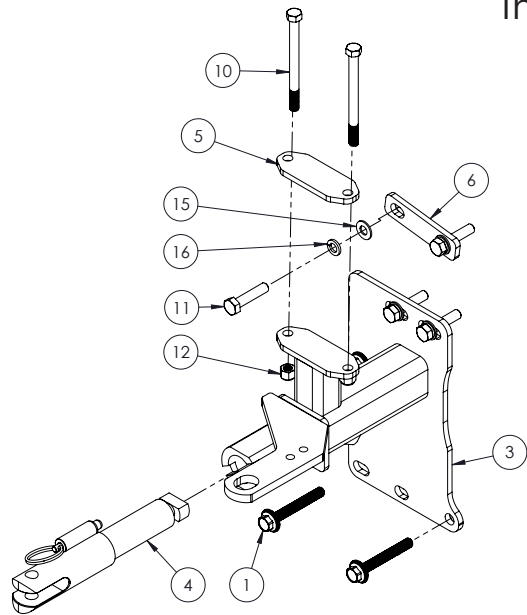

Tools Required

- Flat Screwdriver
- Utility Knife
- Torque Wrench
- Loctite® RED
- Drill
- 1/4" Drill Bit
- 8MM Socket
- 10MM Socket
- 15MM Socket
- 17MM Socket
- 7/16" Socket
- 7/16" Wrench
- 9/16" Socket
- 9/16" Wrench
- 3/4" Wrench
- T30 Torx
- 5/16" Nut Driver

Item No.	Part No.	Description	Qty.
1	Existing	10MM Bolt	6
2	61-8310	BX1141 Baseplate, DS	1
3	61-8311	BX1141 Baseplate, PS	1
4	62-3469	Attachment Tab Assembly with Hole	2
5	101-9004	Plate	2
6	101-10407	1/4" x 1" x 4" Spacer Plate with Slots	2
7	101-10408	Electrical Bracket w/ Breakaway Switch Mount, Short	1
8	201-0050	1/4"-20 x 3/4" Hex Head Bolt, Grade 5, ZP	1
9	201-0071	1/4"-20 x 1" Hex Head Bolt, Grade 5, ZP	2
10	201-0077	3/8"-16 x 4-1/2" Hex Head Bolt, Grade 5, ZP	4
11	201-0594	10MM-1.25 x 40MM Hex Head Bolt, Grade 8.8, ZP	8
12	202-0090	3/8"-16 Hex Nylon Insert Lock Nut, ZP	4
13	202-0102	1/4"-20 Hex Nylon Nut, ZP	3
14	203-0001	1/4" Flat Washer, ZP	2
15	203-0003	3/8" Flat Washer, ZP	8
16	203-0104	10MM Lock Washer, ZP	8
17	226-0049(not shown)	Class IV Safety Cables	2
18	229-0512(not shown)	1/2" Quicklink, ZP	4
19	229-0536(not shown)	6.3MM Plastic Rivets	6
20	290-0437(not shown)	Black Cap Plug Receiver	2

Important:

Use only genuine factory replacement parts on your baseplate. Do **NOT** substitute homemade or non-typical parts. If a bolt is lost or in need of replacement, for your safety and the preservation of your baseplate, be sure to use a replacement bolt of the same grade (In most cases it will be Grade 5, please reference the parts list above). Replacement parts may be ordered through your nearest Blue Ox® Dealer or Distributor. Failing to follow and/or altering these installation instructions in either installation or required equipment will void the manufacturer's warranty. Towing behind a non-motorized vehicle will void the warranty.

BX1144

2019-2023 Jeep Cherokee Aluminium Bumper w/out Tow Hooks (Includes Adaptive Cruise Control, Shuttters, & Technology Package) (2-Speed Transfer Case) Installation Instructions

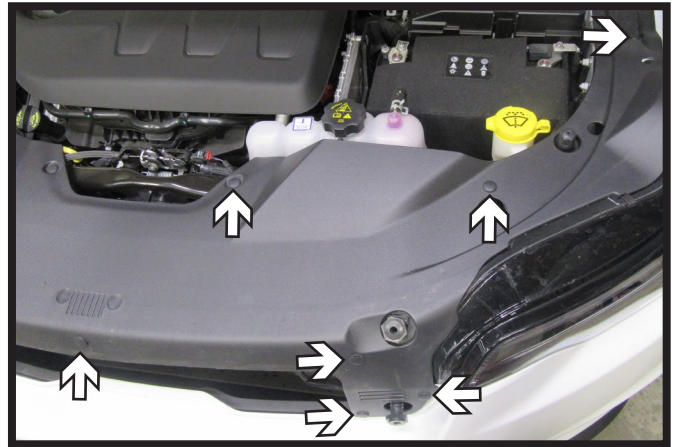
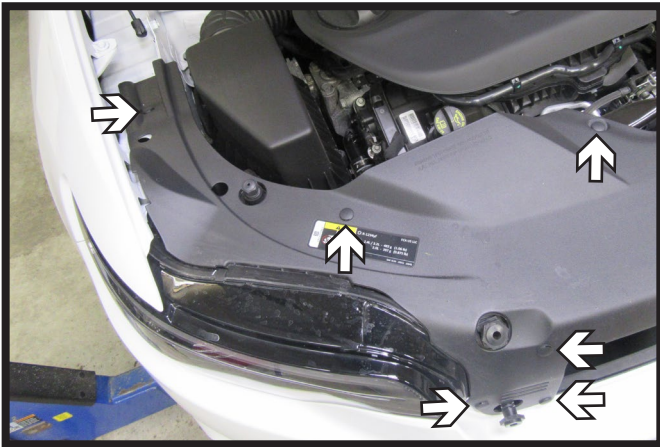

1. Remove the thirteen (13) push pins from the fascia cover. There are six (6) on each side and one (1) in the center. Remove fascia cover and set aside to be reinstalled later.



- 2a. **Some Vehicles:** Using an 8MM socket, remove the four (4) bolts from the edge of the wheel well cover. Pull back the wheel well cover, using a 10MM socket, remove the bolt behind the trim (inset). Do this on both sides of the vehicle.



- 2b. **Some Vehicles:** Using an 8MM socket, remove the two (2) bolts (white) and two (2) push pins (gray) from the edge of the wheel well cover. Pull back the wheel well cover, using a 10MM socket, remove the bolt behind the trim (inset). Do this on both sides of the vehicle.

BX1144

2019-2023 Jeep Cherokee Aluminium Bumper w/out Tow Hooks (Includes Adaptive Cruise Control, Shuttters, & Technology Package) (2-Speed Transfer Case) Installation Instructions

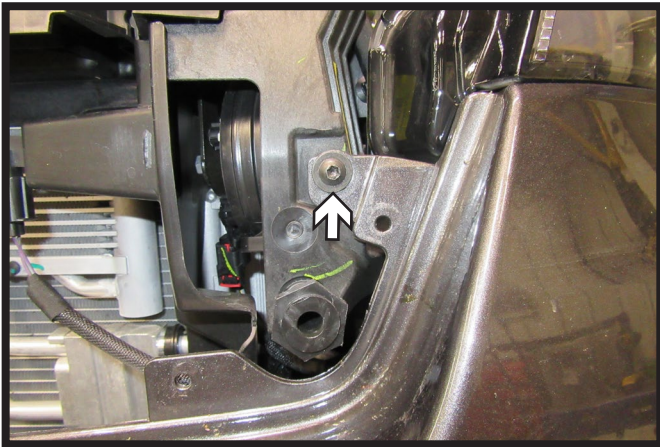

3. Using a T30 Torx, remove the two (2) bolts from the fascia, there is one (1) on each side.



4. Using a 1/4" drill bit, drill out and remove the three (3) pop rivets underneath the vehicle in front of the tire. Do this on both sides of the vehicle.

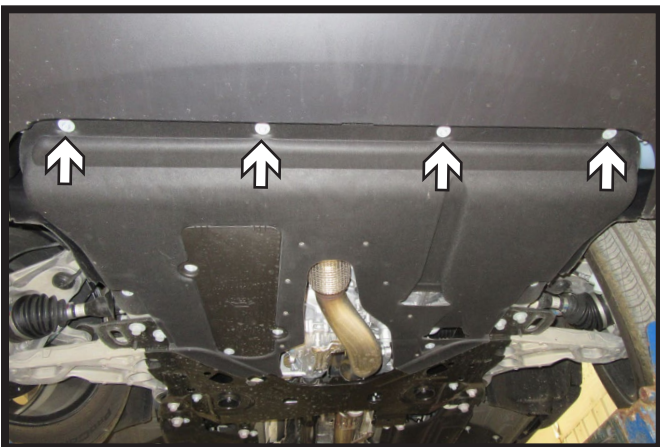

5. Using a 10MM socket, remove the four (4) bolts on the underside of the vehicle.



6. Unsnap the wheel well trim from the backside. Then insert a flat head screw driver between black and white pieces as shown and pull the fascia outward to remove. Do this on both sides of the vehicle.

BX1144

2019-2023 Jeep Cherokee Aluminium Bumper w/out Tow Hooks (Includes Adaptive Cruise Control, Shuttters, & Technology Package) (2-Speed Transfer Case) Installation Instructions

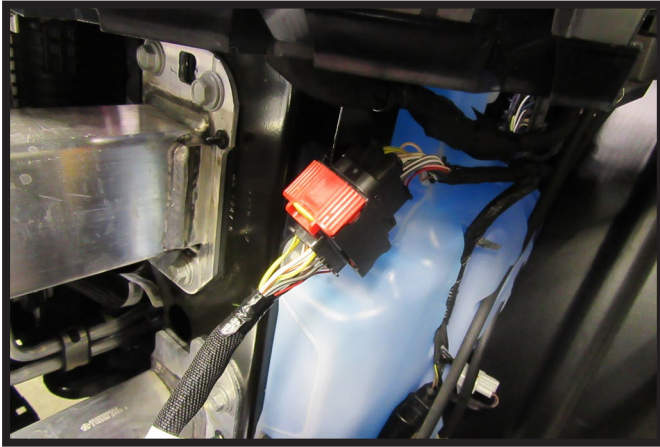

7. As the fascia is removed unhook the plug on the driver side by pulling out the yellow piece and up on the red part to unhook. Remove fascia and set aside to be reinstalled later.

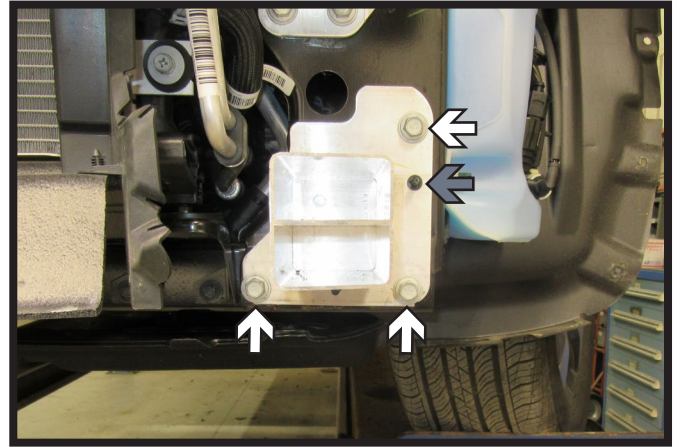

8. Using a 15MM socket, remove the three (3) bolts from the frame extension. Using a 10MM socket, remove the nut (gray) from the frame extension. Do this on both sides of the vehicle. The frame extension will not be reinstalled.

Note: Some vehicles may have a metal clip instead of a nut (gray).

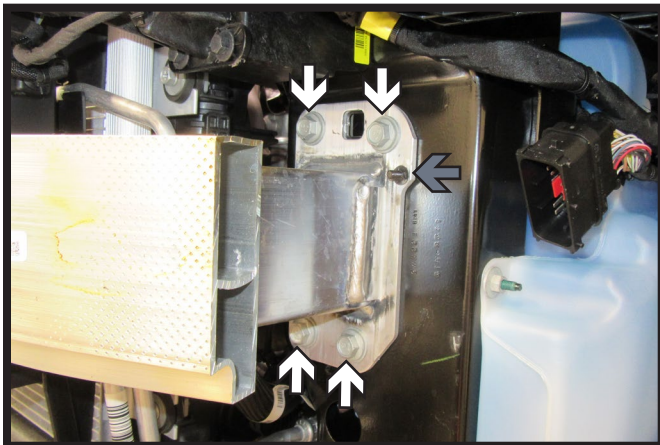

9. Using a 15MM socket, remove the four (4) bolts from the bumper. Using a 10MM socket, remove the nut (gray) from the bumper. Do this on both sides of the vehicle. Remove the bumper and set aside to be reinstalled later.

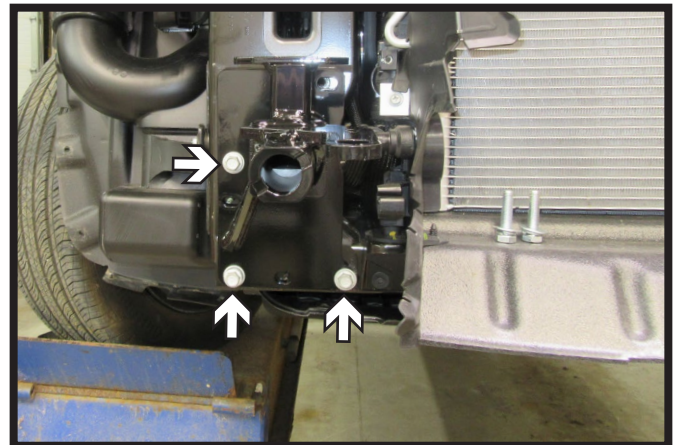

10. On one side of the vehicle, slide the baseplate into place and start the three (3) existing 10MM bolts with flat washers and lock washers. Snug baseplate against frame but do not fully tighten at this time.

BX1144

2019-2023 Jeep Cherokee Aluminium Bumper w/out Tow Hooks (Includes Adaptive Cruise Control, Shuttters, & Technology Package) (2-Speed Transfer Case) Installation Instructions

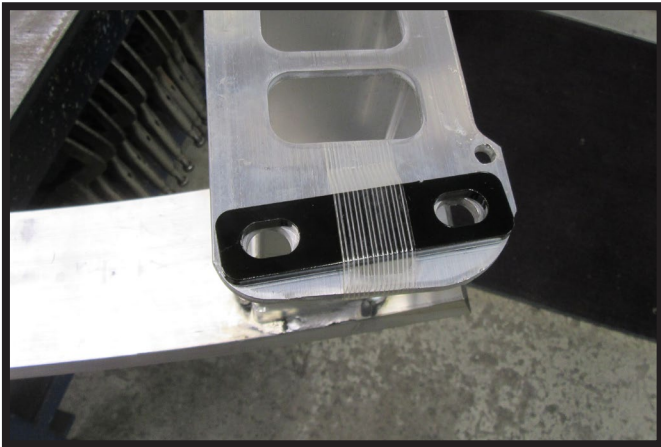

11. A spacer plate will be placed between the bumper and the frame at the top of the bumper. Before reinstalling the bumper, tape the spacer plate in position on the back of the bumper as shown.

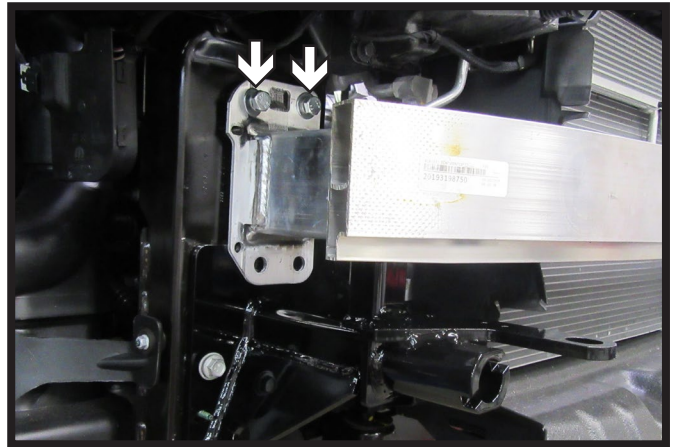

12. Reinstall bumper with spacer plate between the frame and the top of the bumper. Start the two (2) 10MM bolts with flat washers and lock washers. Do this on both sides of the vehicle.

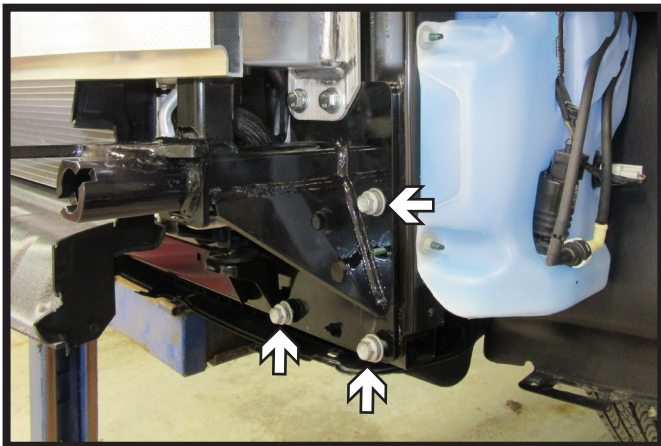

13. Slide the other baseplate onto the vehicle between the bumper and the frame. Start the three (3) existing 10MM bolts with flat washers and lock washers. Ensure the top of the baseplate is up against the bottom of the bumper on both sides of the vehicle.

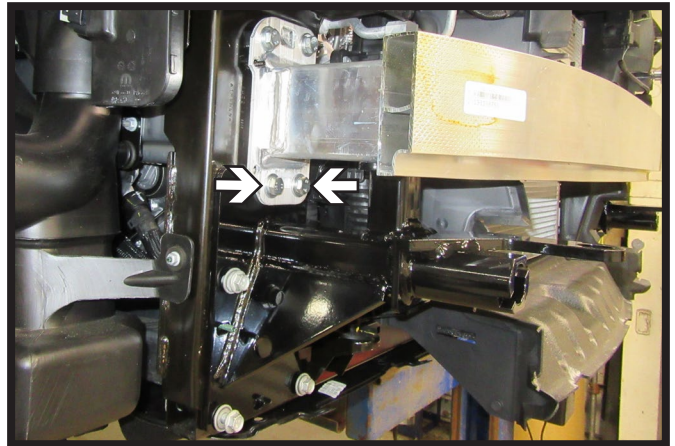

14. Install the bottom two (2) 10MM bolts with flat washers and lock washers into the bottom holes of the bumper. Do this on both sides of the vehicle.

Remove the bottom three (3) 10MM bolts on the baseplate and apply Loctite Red and reinstall. Do this on both sides of the vehicle. Tighten all hardware at this time.

**** Use Loctite® Red on all bolt threads and tighten all bolts to the appropriate torque.****

BX1144

2019-2023 Jeep Cherokee Aluminium Bumper w/out Tow Hooks (Includes Adaptive Cruise Control, Shuttters, & Technology Package) (2-Speed Transfer Case) Installation Instructions

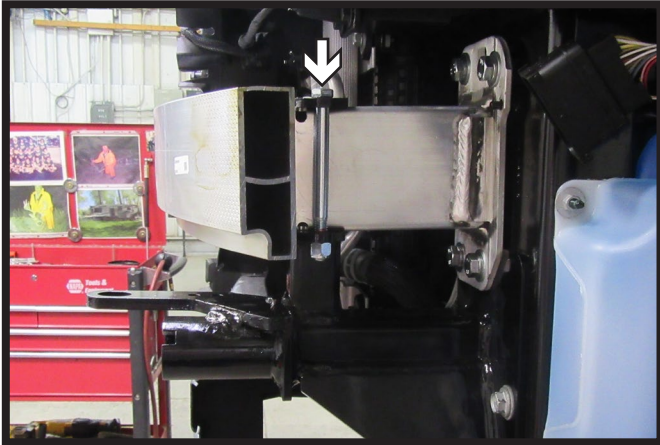

15. Place bracket on top of the bumper and secure to baseplate using two (2) 3/8" x 4-1/2" bolts with nylon lock nuts. Do this on both sides of the vehicle.

**** Use Loctite® Red on all bolt threads and tighten all bolts to the appropriate torque.****



16. Attach the permanent baseplate safety cables to the provided convenience link on the baseplate. The photo above shows the recommended installation of the cables to frame of vehicle. Additional options may interfere with suggested mounting; in this case, secure the cables to a solid piece of the frame as described in the General Information sheet. Be sure the safety cables do not rub against any hoses or moving parts. Do this on **BOTH** sides of the vehicle.

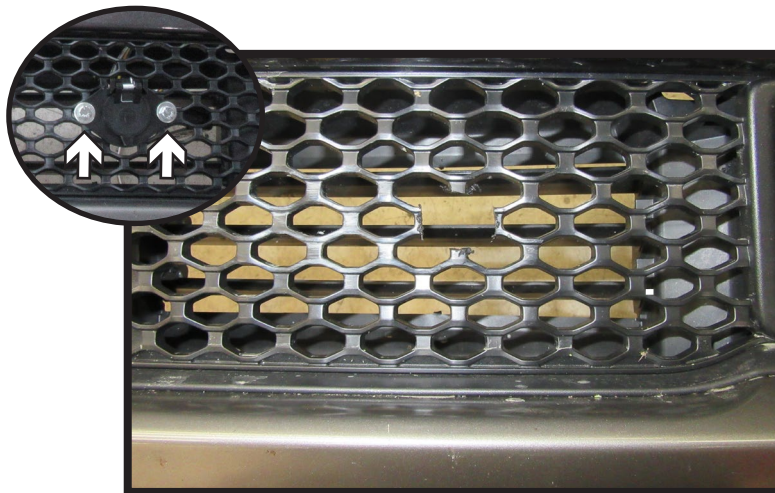

17. **Non-Shuttters Models:** Trim the fascia on one side of the vehicle as shown to allow room for the electrical bracket. Install bracket using two (2) 1/4" bolts with hardware (inset).

**** Use Loctite® Red on all bolt threads and tighten all bolts to the appropriate torque.****

BX1144

2019-2023 Jeep Cherokee Aluminium Bumper w/out Tow Hooks (Includes Adaptive Cruise Control, Shutters, & Technology Package) (2-Speed Transfer Case) Installation Instructions

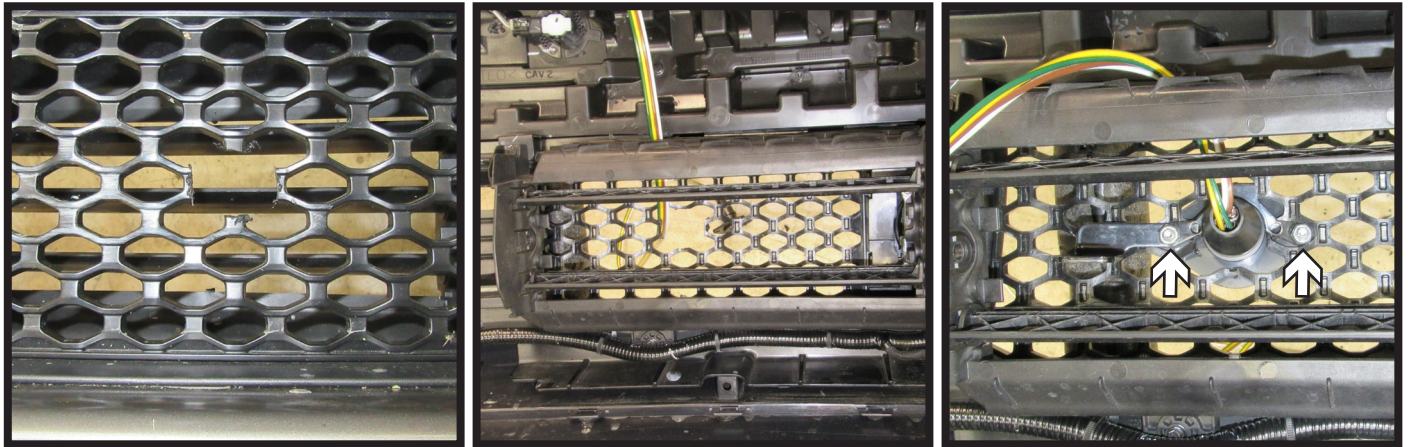

18. **Shutter Models:** Trim the fascia as shown on one side of the vehicle to allow room for the electrical (left). On the back side of the fascia remove the middle shutter to allow room to attach electrical bracket (center). Set aside shutter to be trimmed and reinstalled later. Cut a hole in the top of the shutter housing to run electrical through and install electrical bracket using two (2) 1/4" bolts with hardware (right).

**** Use Loctite® Red on all bolt threads and tighten all bolts to the appropriate torque.****

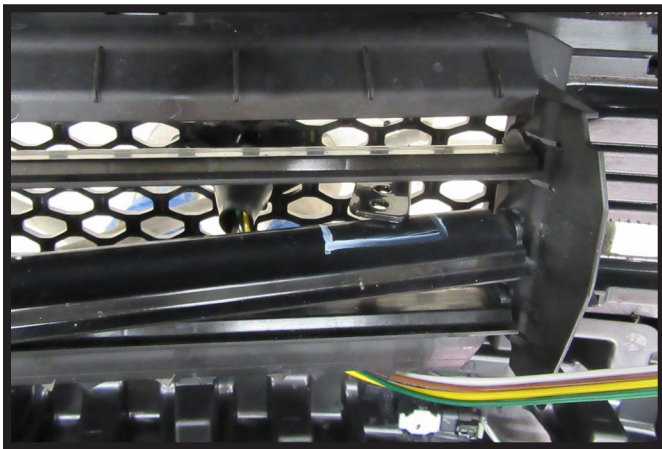

19. **Shutter Models:** Mark and trim shutter as shown before reinstalling. Ensure that shutters can fully open and close once reinstalled and no electrical is in the way of shutters.
Note: If installing a breakaway switch trim fascia and install switch before reinstalling shutter.

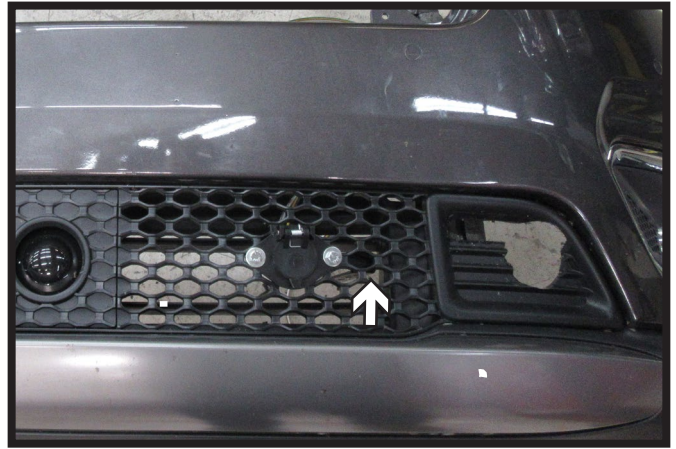

20. **Optional:** Trim fascia to allow room for breakaway switch. Attach breakaway switch to the electrical mounting bracket using one (1) 1/4" bolt and nut (gray).

**** Use Loctite® Red on all bolt threads and tighten all bolts to the appropriate torque.****

BX1144

2019-2023 Jeep Cherokee Aluminium Bumper w/out Tow Hooks (Includes Adaptive Cruise Control, Shutters, & Technology Package) (2-Speed Transfer Case) Installation Instructions

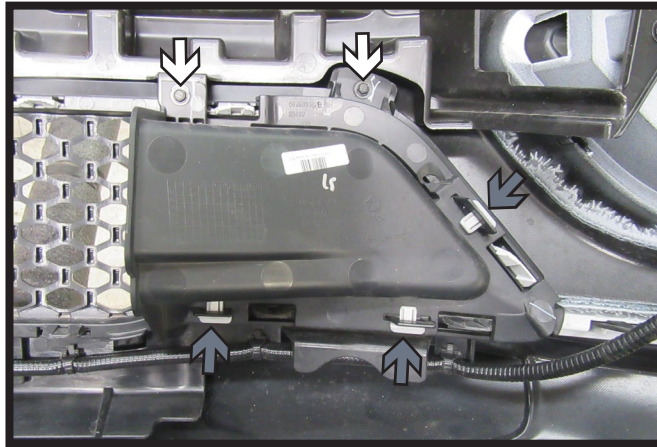

21. **Non-Shutter Models:** Using a 7MM socket, remove the two (2) bolts (white) from the air dam on the back side of the fascia. Unclip the three (3) clips (gray) by pushing down on the inside of the clip. Remove the air dam. Do this on both sides of the vehicle.



- 22a. **Non-Shutter Models:** Remove the horizontal slats from the corner of the fascia as shown. Do this on both sides of the vehicle.



- 22b. **Shutter Models:** Hold the fascia as close to its original position, mark and trim the fascia around the convenience links and attachment tabs.

BX1144

2019-2023 Jeep Cherokee Aluminium Bumper w/out Tow Hooks (Includes Adaptive Cruise Control, Shuttters, & Technology Package) (2-Speed Transfer Case) Installation Instructions



23. Reinstall the fascia and fascia cover. Reconnect all electrical connections.

Note: Install new plastic rivets into the underside of the fascia, where the factory rivets were removed.

CUSTOMER SERVICE COMMITMENT

Blue Ox® is committed to providing you with exceptional customer care throughout your lifetime with our products. Our team is here to assist you with any questions you may have regarding the performance of your product. Simply call (402) 385-3051 and you can speak with our technical service team.

Additionally, please visit our website to see which rallies our Destination America team will be attending. For a nominal fee, our service technician will service your towing system to ensure it's in proper working condition. Also, as a commitment to our customers, should you visit our factory, you can stay at our full service Blue Ox® campground at no charge along with enjoying a factory tour.

Again, thank you for being our customer and for the confidence you have shown in the performance of our products. It is because of customers like you we enjoy the success we have today.

© 2022 Blue Ox
One Mill Road, Industrial Park
Pender, Nebraska 68047
Phone: (402) 385-3051
Fax: (402) 385-3360
www.blueox.com

General Information

1. Ensure that your product(s) are registered online at www.blueox.com. It is crucial to register your product(s) so that you may be alerted of product offerings, updates, upgrades, maintenance and safety bulletins, and/or recalls.
2. **It is the owner's responsibility to inspect all towing equipment for cracked welds, missing or worn parts and loose bolts before each towing trip.** Be sure to use Loctite® Red on all bolts and tighten to the recommended specifications.
3. **It is the owner's responsibility to hook up all towing equipment per manufacturer's instructions/ recommendations.**
4. Remove the attachment tabs when not in use (if applicable).

Notice To Baseplate Installer

1. It is YOUR responsibility to watch for:

- Oil cooler and air conditioner lines
- Electrical wires and hoses
- Missing parts or attaching points on the frame

** If the baseplate is improperly installed and is against a wire or hose, it could cause fluid leaks or electrical shorts some time after the actual baseplate installation.

Permanent Baseplate Safety Cable Installation

Permanent baseplate safety cables are strongly recommended when towing a vehicle with a tow bar. The principle function of the permanent baseplate safety cables is to prevent the towed vehicle from breaking loose in the event the connection between the frame of the towed vehicle and the baseplate fails or becomes disconnected. The cables must be connected from the baseplate to the frame rail or cross member of the vehicle's frame. The illustrations below show the possible arrangements recommended by Blue Ox®. Each permanent baseplate safety cable must have an adequate weight rating for the towing system. The weight rating of the two (2) cables together will not qualify.

Do not mount the permanent baseplate safety cables against wires, hoses or brake lines.

These permanent baseplate safety cables should remain installed as long as the baseplate is installed on the vehicle. Permanent baseplate safety cables are to be used in conjunction with, and NOT a replacement for legally required safety cables attaching the towed vehicle to the towing vehicle.

Option #1

(Baseplates with Convenience Link Tabs)

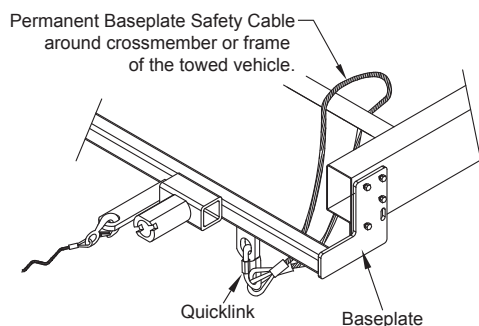

Option #2

(Baseplates with out Convenience Link Tabs)

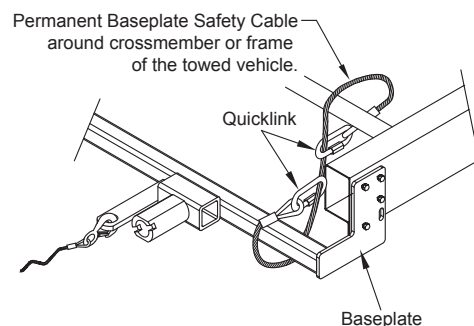

BLUE OX ORIGINAL PURCHASERS THREE YEAR LIMITED WARRANTY

Automatic Equipment Manufacturing Company ("Automatic") warrants to the original (first) retail purchaser that this product, manufactured by Automatic, shall be free from defect in material and workmanship under normal use and service for a period of three years from the date of delivery.

During said three-year period, Automatic will repair or replace any parts that have been returned by the original purchaser, to the factory, transportation prepaid, and in Automatic's sole and absolute opinion found to be defective.

Limitations on Warranty Coverage:

Coverage under this warranty will be valid only if the customer warranty card is returned by the original purchaser within 30 days of purchase.

Coverage under this warranty will be effective only when a copy of the original invoice, showing date and place of purchase, accompanies any claim for warranty. This warranty is NON TRANSFERABLE.

This limited warranty will not cover, in any way or form, any alleged damages caused by incorrect or improper installation, improper use, modification or neglect of product, failure to properly service and maintain, misuse, act of God, accident or failure of the user to follow guidelines contained in the instructional material provided by Automatic.

This warranty does not cover normal wear and tear, paint or rust.

Warrantor assumes no responsibility to the owner for loss of use of product, loss of time, inconvenience or any other damage consequential or otherwise. Including, but not limited to mileage, expense of transporting of product, return shipping expense, mechanics travel time, telephone, road service, towing, and rental during repairs, travel, lodging, loss or damage to personal property or loss of earnings.

REPAIR OR REPLACEMENT AS SET FORTH IN THIS LIMITED WARRANTY IS THE SOLE EXCLUSIVE REMEDY OF THE PURCHASER. AUTOMATIC SHALL NOT BE LIABLE FOR ANY INCIDENTAL OR CONSEQUENTIAL DAMAGES FOR BREACH OF ANY EXPRESS OR IMPLIED WARRANTY ON THIS PRODUCT. EXCEPT TO THE EXTENT PROHIBITED BY APPLICABLE LAW, ANY IMPLIED WARRANTY OF MERCHANTABILITY OR FITNESS FOR A PARTICULAR PURPOSE ON THIS PRODUCT IS LIMITED IN LENGTH TO THE DURATION OF THIS WARRANTY.

Please visit <http://blueox.com/warranty/> to register your warranty



BLUE OX