



BX2251

2008-10 Honda Odyssey
 2009-15 Honda Pilot
 Installation Instructions

Please read **BOTH** these Installation Instructions and the General Instructions prior to installing or operating this equipment.

- Blue Ox® towing products and accessories are intended to be installed by Blue Ox® Dealers who are familiar with our products and have the equipment and knowledge necessary to do “fit work”. If needed, Blue Ox® Dealers can be found at www.blueox.com or by contacting our Customer Care Department at (402) 385-3051.
- Many Blue Ox® baseplates are designed to use existing holes and hardware to mount the baseplate to the towed vehicle. Even though bolts are there, do not assume they are adequate for baseplate mounting. Always use the hardware supplied in the hardware kit and existing hardware as specified in the installation instructions.

Serial Number

Attachment Tab Height: 14-1/2”

Attachment Tab Width: 18”

Bolt Torque Specifications

Torque in Foot-Pounds for Inch Bolts

Bolt Size	Grade 5	Grade 8
1/4”	10	14
5/16”	19	29
3/8”	33	47
7/16”	54	78
1/2”	78	119
5/8”	154	230
3/4”	257	380



If the front of your vehicle looks different than this, please contact us at (402)385-3051.

Bolt Torque Specifications

Torque in Foot-Pounds for Metric Bolts

Bolt Size	Grade 8.8	Grade 10.9
6MM	6	8
8MM	16	22
10MM	31	40
12MM	54	70
14MM	89	117
16MM	161	230
18MM	222	318



WARNING

Failure to read and follow these instructions could result in separation of the towed vehicle from the tow bar, causing property damage, loss of towed vehicle, personal injury or death.

Reference your vehicle owner’s manual for manufacturer’s towing specifications.

BX2251
2008-10 Honda Odyssey
2009-15 Honda Pilot
Installation Instructions

Instruction Notes: The fascia cover, fascia and headlights are removed and reinstalled for the baseplate installation. The bumper is removed and not reinstalled. Some drilling and trimming is required.

Place all components that are removed on a flat, sturdy surface. All items will be reinstalled unless otherwise noted after the baseplate is installed.

The dimensional variations between otherwise identical vehicles can be considerable. While the baseplate was designed for easy installation, it may be necessary to tailor the baseplate slightly to compensate for vehicle manufacturer's tolerances.

The BX8869 Tail Light Wiring Kit is recommended for this vehicle.



Drill a hole according to the tail
light wiring kit instructions.

NOTICE

- Handling of some cosmetic parts when installing this product may require the use of protective covers, rags, specialty tools, etc. to prevent damage.
- When using power drills be aware of the dangers of torque and drill bit length.
- When using a reciprocating saw be aware of objects behind the cutting surface.
- Use a good quality paint to spray cut edges of frame to prevent rusting.
- Be sure that **ALL** electrical connections are plugged in and accessories are functioning properly before reinstalling the fascia.
- The baseplate is computer tested to your vehicle's GVWR, exceeding this weight will void the manufacturer's warranty.
- Be sure to use Loctite® Red on all bolts before tightening. Tighten all bolts according to the torque chart provided.
- Dealer or installer be certain the user receives these instruction sheet.
- If the baseplate is in an accident, it must be replaced. **DO NOT** use it again! An accident can cause unseen damage and using it again could result in more damage or serious injury. **DO NOT** use the baseplate if it is damaged or missing parts.

BX2251
2008-10 Honda Odyssey
2009-15 Honda Pilot
Installation Instructions

Tools Required

Large Vise Grip
Flat Screwdriver
Utility Knife
Phillips Screwdriver
Torque Wrench
Drill
Reciprocating Saw
Tape Measure
Loctite® RED
13/32" Drill Bit
10MM Socket
12MM Socket
12MM Wrench
9/16" Socket
9/16" Wrench

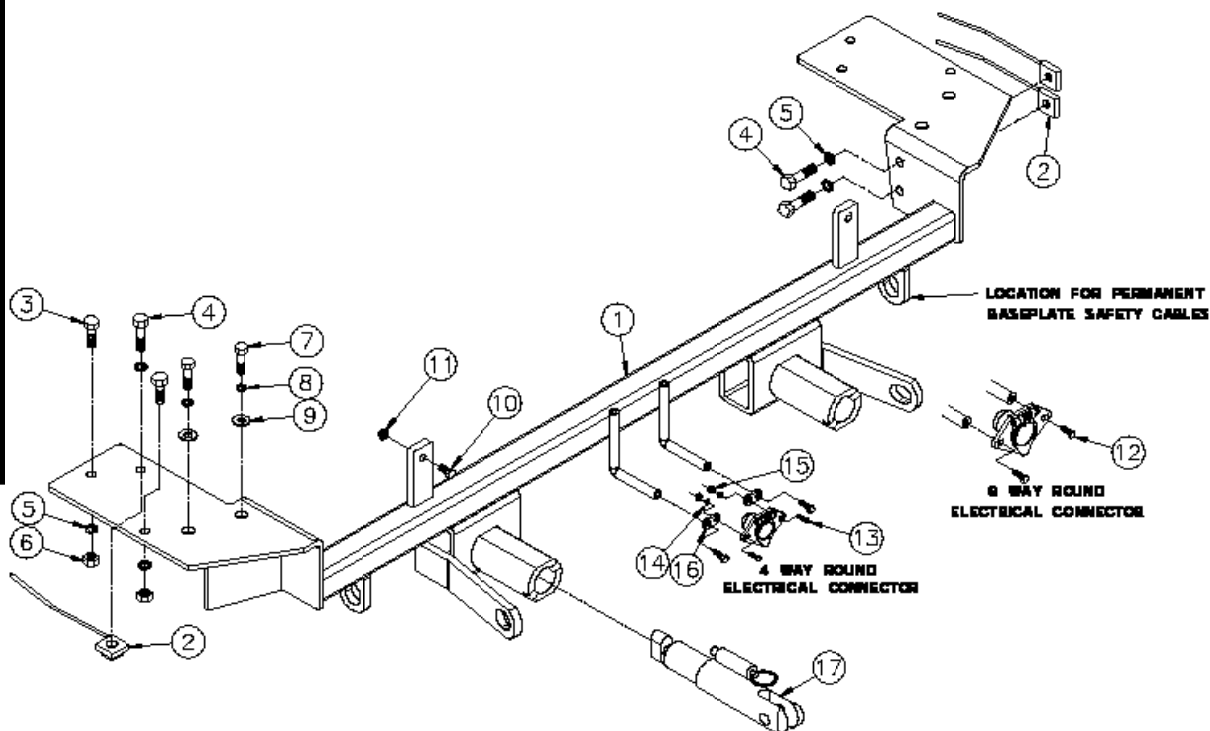

Item No.	Part No.	Description	Qty.
1.....	61-6716	BX2251 Baseplate.....	1
2.....	61-5208	3/8"-16 Nutplate w/ 14" Wire	6
3.....	201-0443	3/8"-16 x 1" Hex Head Bolt, Grade 5, ZP	4
4.....	201-0440	3/8"-16 x 1-1/2" Hex Head Bolt, Grade 5, ZP	6
5.....	203-0010	3/8" Lock Washer, ZP	10
6.....	202-0003	3/8"-16 Hex Nut, ZP.....	8
7.....	201-0046	8MM-1.25 x 30MM Hex Head Bolt, Grade 8.8, ZP.....	4
8.....	203-0102	8MM Lock Washer, ZP	4
9.....	203-0003	3/8" Flat Washer, ZP.....	4
10.....	201-0050	1/4"-20 x 3/4" Hex Head Bolt, Grade 5, ZP	2
11.....	202-0069	1/4"-20 Hex Flange Whiz Lock Nut, ZP	2
12.....	201-0979	#12-14 x 1" Self Drilling Screw, ZP.....	2
13.....	201-0192	#10-32 1/2" Round Slotted Head Screw.....	2
14.....	203-0054	#10 Lock Washer, ZP	2
15.....	202-0047	#10-32 Hex Nut	2
16.....	101-5822	4 Way Connector Adapter	2
17.....	62-3469	Attachment Tab Assembly with Hole	2
18.....	226-0046(not shown)	Class III Safety Cables	2
19.....	229-0359(not shown)	3/8" Quicklink, ZP	2
20.....	290-0437(not shown)	Black Cap Plug Receiver.....	2

Important:

Use only genuine factory replacement parts on your baseplate. Do **NOT** substitute homemade or non-typical parts. If a bolt is lost or in need of replacement, for your safety and the preservation of your baseplate, be sure to use a replacement bolt of the same grade (In most cases it will be Grade 5, please reference the parts list above). Replacement parts may be ordered through your nearest Blue Ox® Dealer or Distributor. Failing to follow and/or altering these installation instructions in either installation or required equipment will void the manufacturer's warranty. Towing behind a non-motorized vehicle will void the warranty.

BX2251
2008-10 Honda Odyssey
2009-15 Honda Pilot
Installation Instructions

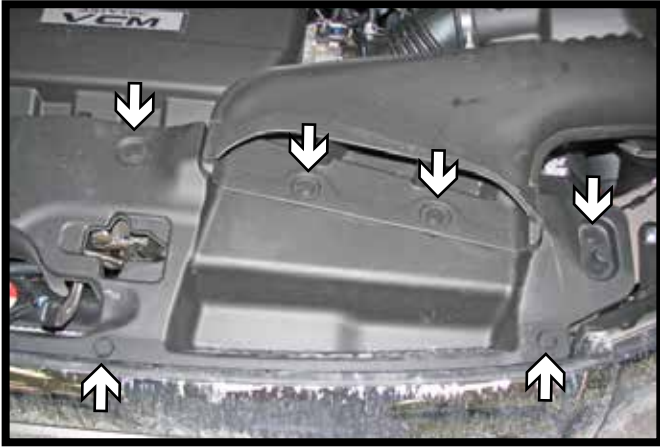

1. Remove the nine (9) push pins from the fascia cover. There are six (6) on the driver side and three (3) on the passenger side. Set the cover aside.



2. Using a 10MM socket, remove the screw from the top corner of the fascia. Do this on both sides of the vehicle.



3. Using a Phillips screwdriver, remove the two (2) screws from the wheel well. Do this on both sides of the vehicle.
2012 and up Pilot models: Remove the additional screw located up from lower two (2) screws (inset). Do this on both sides of the vehicle.



4. Using a 10MM socket, remove the screw from the underside corner of the fascia (white). Then remove the two (2) push pins (gray). Do this on both sides of the vehicle.

BX2251
2008-10 Honda Odyssey
2009-15 Honda Pilot
Installation Instructions



5. Remove the seven (7) push pins along the front edge of the fascia. Remove the fascia from the vehicle disconnecting all electrical connections and set the fascia aside.



6. Remove the temperature sensor from the top of bumper.

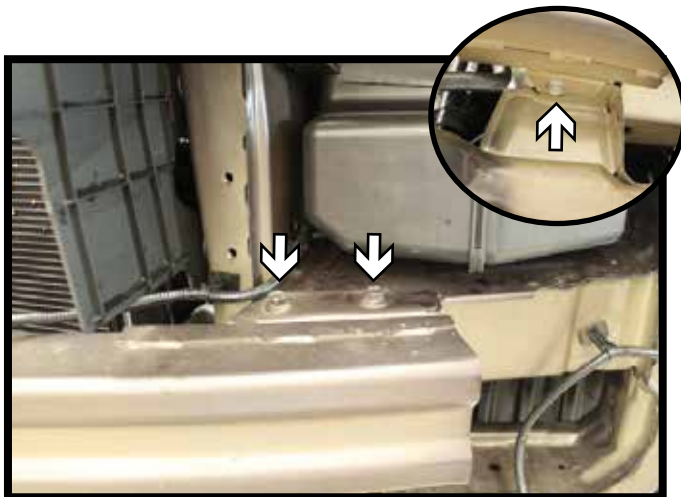

7. Using a 12MM socket, remove the three (3) bolts from the bumper. There are two (2) on the top side and one (1) underneath. Do this on both sides of the vehicle. The bumper will not be reinstalled.



8. Using a 10MM socket, remove the screw from the top of the headlight (white). Then remove the push pin (gray). Do this on both sides of the vehicle.

BX2251
2008-10 Honda Odyssey
2009-15 Honda Pilot
Installation Instructions

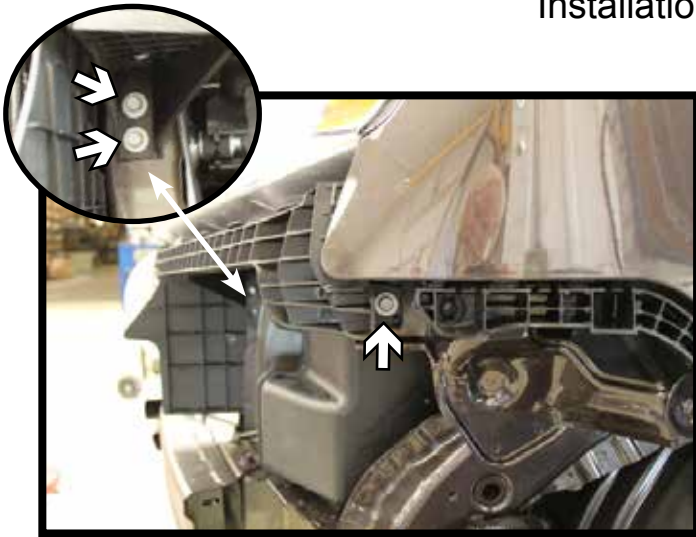

9. Using a 10MM socket, remove the three (3) screws from the headlight. There is one (1) on the side and two (2) in front. Do this on both sides of the vehicle. Remove both headlights, disconnecting all electrical connections and set aside.



10. Using a 10MM socket, remove the two (2) screws from coolant line brackets.

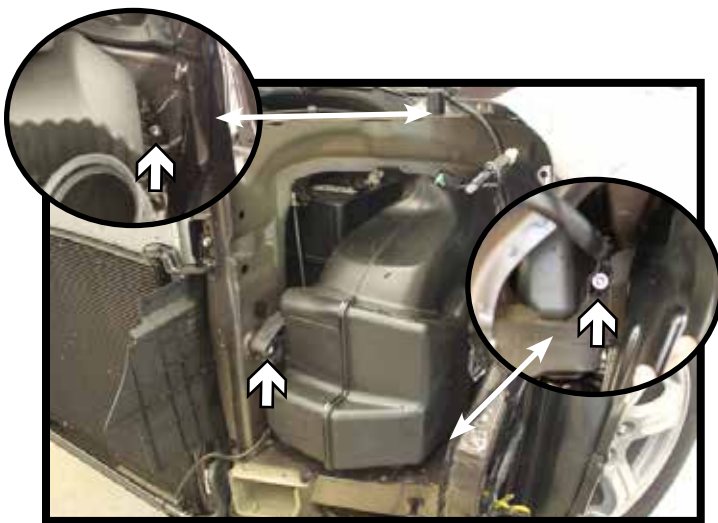

11. Using a 10MM socket, remove the three (3) screws from the air baffle on the driver side. There is one (1) on top, one (1) in the front and one (1) on the side. Set the baffle aside.

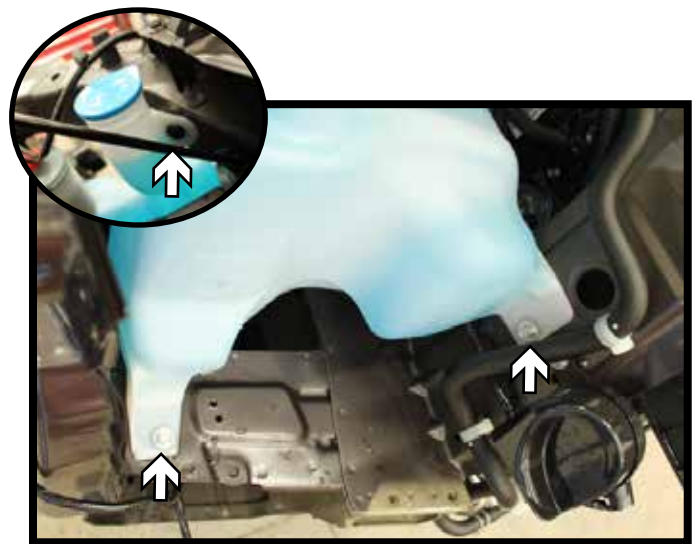

12. Using a 10MM socket, remove the two (2) screws from the washer reservoir on the passenger side. Then remove the push pin from the filler neck (inset). Disconnect and plug all lines and set the reservoir aside.

BX2251
2008-10 Honda Odyssey
2009-15 Honda Pilot
Installation Instructions



13. Cut a slit along the top edge of the frame webbing and another 1/2" above the frame with the reciprocating saw. Be aware to not cut into coolant lines, radiator or electrical wiring. Bend the webbing toward the headlight area. Do this to both sides of the vehicle. This will open the area for the baseplate installation.

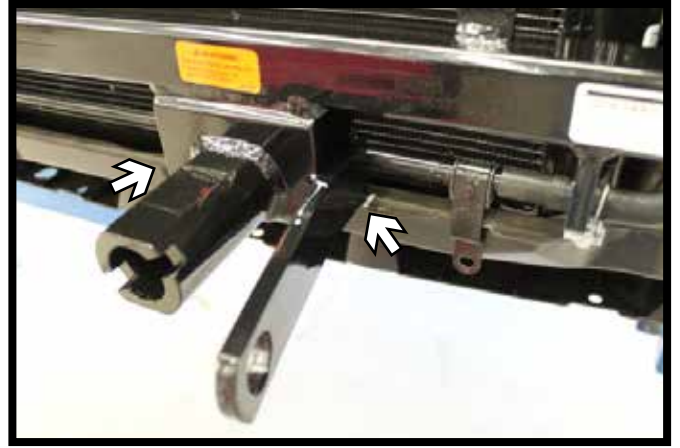

14. Position the baseplate onto the vehicle. Make a mark on either side of the attachment tab tube onto the radiator support. Do this on both attachment tubes and set the baseplate aside.

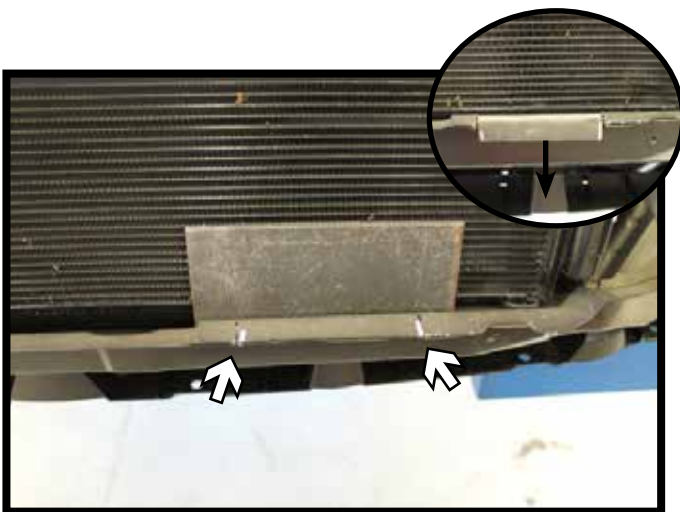

15. On the driver side, using a reciprocating saw, cut slits in the radiator support lip back to the face. Bend the tab down.

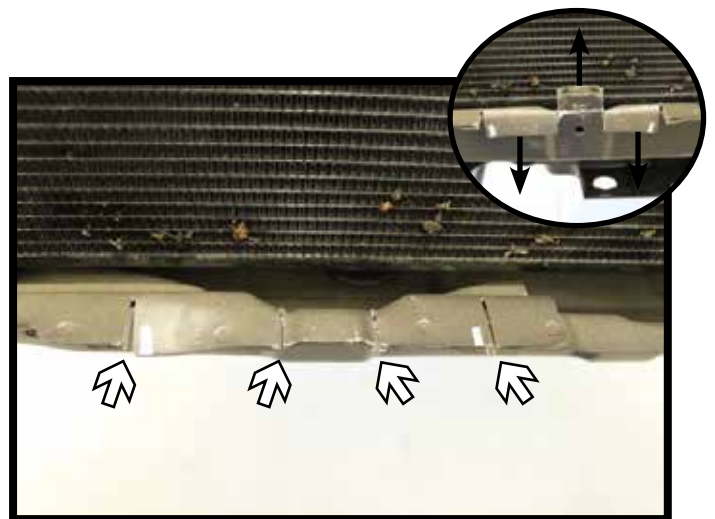

16. On the passenger side, using a reciprocating saw, cut four (4) slits in the radiator support lip back to the face. Bend the outer tabs down and the middle tab up.

BX2251
2008-10 Honda Odyssey
2009-15 Honda Pilot
Installation Instructions

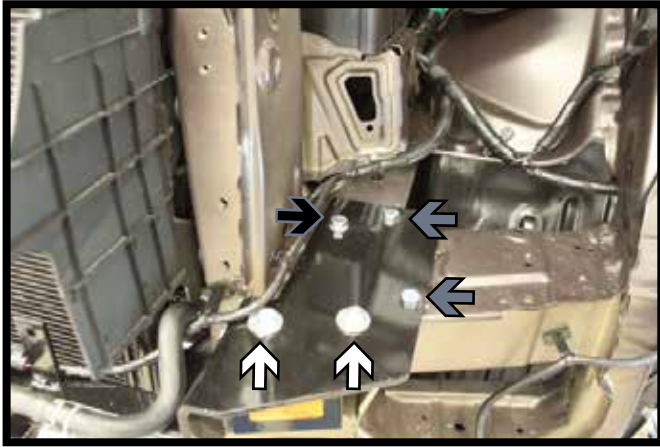

17. Position the baseplate onto the vehicle and align the two front holes (white) of the baseplate with the existing holes in the frame and install 8MM bolts with 8MM lock washers, and 3/8" flat washers and fully tighten. Do this on both sides of the vehicle.

Using a 13/32" drill bit, drill the remaining holes in the baseplate thru the frame. Install 3/8"-16 x 1" bolts into the outside two holes (gray) with 3/8" lock washers and the hex nuts on the back side of the frame webbing. Install a 3/8"-16 x 1-1/2" bolt with a 3/8" lock washer into the back inside hole (black) and a 3/8"-16 nut plate on the inside of the frame. Do this on both sides of the vehicle. Fully tighten all hardware.

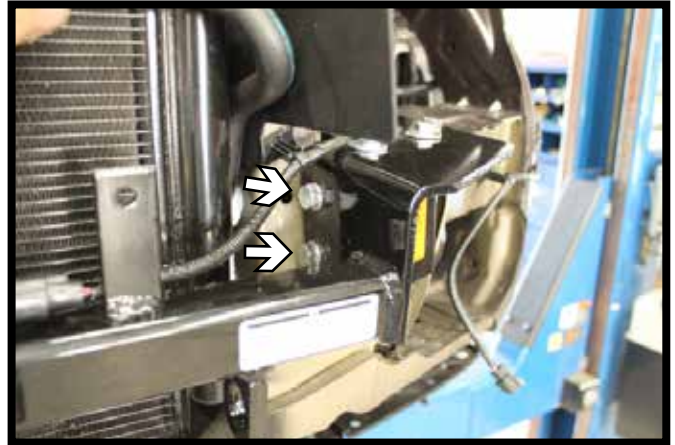

18. Using a 13/32" drill bit, drill the inner holes in the baseplate thru the frame. Install 3/8"-16 x 1-1/2" bolts with 3/8" lock washers into the holes. Do this on both sides of the vehicle. Fully tighten all hardware.

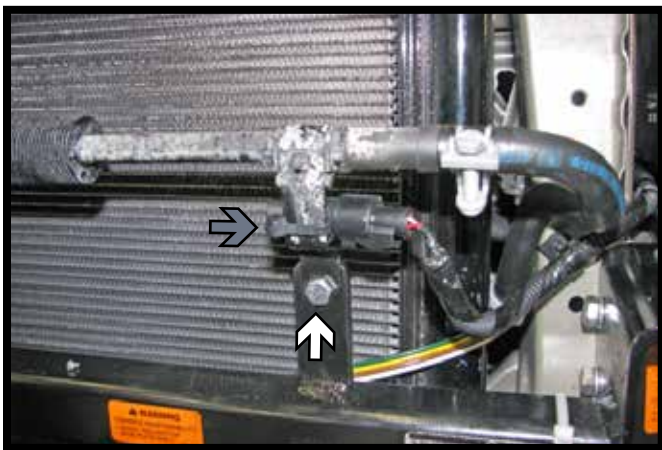

19. Reattach the coolant line to the tabs on the baseplate with 1/4"-20 x 3/4" bolts and 1/4"-20 lock nuts.
Reattach the temperature sensor to the bracket with a zip-tie (gray).

20. Attach the permanent baseplate safety cables to the provided convenience link on the baseplate. The photo above shows the recommended installation of the cables to frame of vehicle. Additional options may interfere with suggested mounting; in this case, secure the cables to a solid piece of the frame as described in the instructions included with the permanent baseplate safety cables. Be sure the safety cables do not rub against any hoses or moving parts. Do this on **BOTH** sides of the vehicle.

BX2251
2008-10 Honda Odyssey
2009-15 Honda Pilot
Installation Instructions

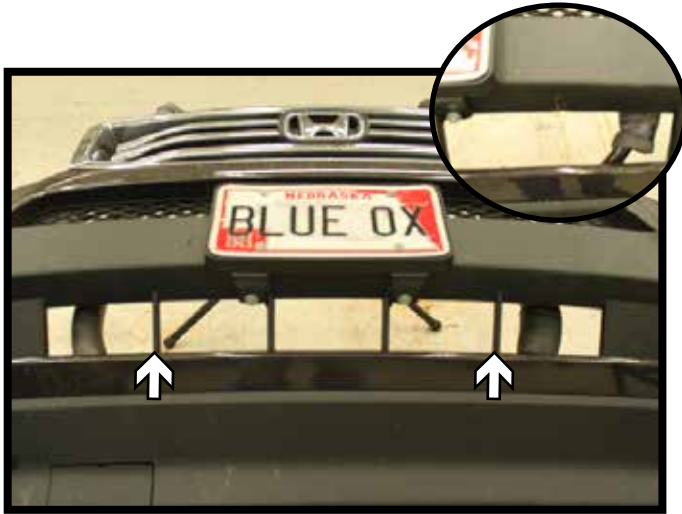

21. Trim the outer ribs of the lower part of the fascia off on both sides of the fascia.



22. Reinstall the washer reservoir, headlights, air baffle, fascia and fascia cover.

CUSTOMER SERVICE COMMITMENT

Blue Ox® is committed to providing you with exceptional customer care throughout your lifetime with our products. Our team is here to assist you with any questions you may have regarding the performance of your product. Simply call (402) 385-3051 and you can speak with our customer care team.

Additionally, please visit our website to see which rallies our Destination America team will be attending. For a nominal fee, our service technician will service your towing system to ensure it's in proper working condition. Also, as a commitment to our customers, should you visit our factory, you can stay at our full service Blue Ox® campground at no charge along with enjoying a factory tour.

Again, thank you for being our customer and for the confidence you have shown in the performance of our products. It is because of customers like you we enjoy the success we have today.

© 2014 Blue Ox
One Mill Road, Industrial Park
Pender, Nebraska 68047
Phone: (402) 385-3051
Fax: (402) 385-3360
www.blueox.com

General Information

1. Ensure that your product(s) are registered online at www.blueox.com. It is crucial to register your product(s) so that you may be alerted of product offerings, updates, upgrades, maintenance and safety bulletins, and/or recalls.
2. **It is the owner's responsibility to inspect all towing equipment for cracked welds, missing or worn parts and loose bolts before each towing trip.** Be sure to use Loctite® Red on all bolts and tighten to the recommended specifications.
3. **It is the owner's responsibility to hook up all towing equipment per manufacturer's instructions/recommendations.**
4. Remove the attachment tabs when not in use (if applicable).

Notice To Baseplate Installer

1. It is YOUR responsibility to watch for:

- Oil cooler and air conditioner lines
- Electrical wires and hoses
- Missing parts or attaching points on the frame

** If the baseplate is improperly installed and is against a wire or hose, it could cause fluid leaks or electrical shorts some time after the actual baseplate installation.

Permanent Baseplate Safety Cable Installation

Permanent baseplate safety cables are strongly recommended when towing a vehicle with a tow bar. The principle function of the permanent baseplate safety cables is to prevent the towed vehicle from breaking loose in the event the connection between the frame of the towed vehicle and the baseplate fails or becomes disconnected. The cables must be connected from the baseplate to the frame rail or cross member of the vehicle's frame. The illustrations below show the possible arrangements recommended by Blue Ox®. Each permanent baseplate safety cable must have an adequate weight rating for the towing system. The weight rating of the two (2) cables together will not qualify.

Do not mount the permanent baseplate safety cables against wires, hoses or brake lines.

These permanent baseplate safety cables should remain installed as long as the baseplate is installed on the vehicle. Permanent baseplate safety cables are to be used in conjunction with, and NOT a replacement for legally required safety cables attaching the towed vehicle to the towing vehicle.

OPTION #1

Permanent Baseplate Safety Cables to Cross Member or Frame of Towed Vehicle.

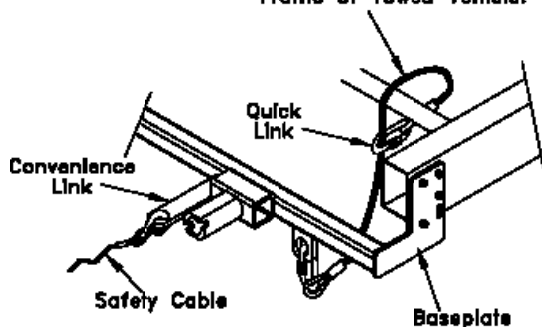

OPTION #2

Permanent Baseplate Safety Cables to Cross Member or Frame of Towed Vehicle.

