



Baseplate Installation Instructions

BX3518 2004-05 Suzuki Grand Vitara 2006 Suzuki XL7 Installation Instructions

Serial Number

Please read BOTH these Installation Instructions and the General Instructions before attempting to install or operate this equipment.

- Blue Ox® towing products and accessories are intended to be installed by Blue Ox® Dealers who are familiar with our products and have the equipment necessary and knowledge to do "fit work". When necessary Blue Ox® Dealers can be found at www.blueox.us or by contacting our Customer Care Department at (402) 385-3051 or toll free (888) 425-5382.
- Many Blue Ox® Baseplates are designed to use existing holes and hardware to mount the baseplate to the towed vehicle. Even though bolts are there, do not assume they are adequate for baseplate mounting. Always use hardware supplied in the hardware kit and existing hardware specified in the Baseplate Installation Instructions.

Attachment Tab Height: 17"

Attachment Tab Width: 20"

Bolt Torque Specifications
Torque in Foot-Pounds per Metric Bolts

Bolt Size	Grade 8.8	Grade 10.9
6MM	6	8
8MM	16	22
10MM	31	40
12MM	54	70
14MM	89	117

Confirm the towability and pre-towing procedures for your vehicle with the owner's manual or contact the vehicle's manufacturer for specific towing procedures. You can also contact REMCO for additional information at 1(800)228-2481.

Bolt Torque Specifications
Torque in Foot-Pounds per Inch Bolts

Bolt Size	Grade 5	Grade 8
1/4"	10	14
5/16"	19	29
3/8"	33	47
7/16"	54	78
1/2"	78	119
5/8"	154	230



! WARNING

Failure to read and follow these instructions could result in separation of the towed vehicle from the tow bar, causing property damage, loss of towed vehicle, personal injury or death.

BX3518
2004-05 Suzuki Grand Vitara
2006 Suzuki XL7
Installation Instructions

Parts List

Ref. No.	Qty.	Part #	Description
1	1	61-5963	Weldment, Baseplate, BX3518
2	6	61-5208	3/8" Nutplate, with Wire
3	6	201-0440	3/8-16 x 1 1/2" Bolt, Grade 5, ZP
4	6	203-0010	3/8" Lock Washer, ZP
5	2	201-0979	#12-14 X 1" Self Drilling Screw, ZP
6	2	202-0047	#10-32 Hex Nut
7	2	203-0054	#10 Lock Washer
8	2	201-0192	#10-32 x 1/2" Slot, Rd. Hd. Screw
9	2	101-5822	Adapter, 4 Way Connector
10	2	62-3468	Attachment, Assembly, SF/SB (R)
	2	226-0046	Baseplate Safety Cable, 36" CL III (Not Shown)
	2	229-0359	Quicklink, 3/8, ZP (Not Shown)
	2	290-0437	Receiver, Cap Plug (Blk) (Not Shown)

Tools Required

- 10MM Socket
- 12MM Socket
- 9/16" Socket
- 13/32" Drill Bit
- Vise Grips
- Flat Chisel
- Phillips Screwdriver
- LOCTITE Red

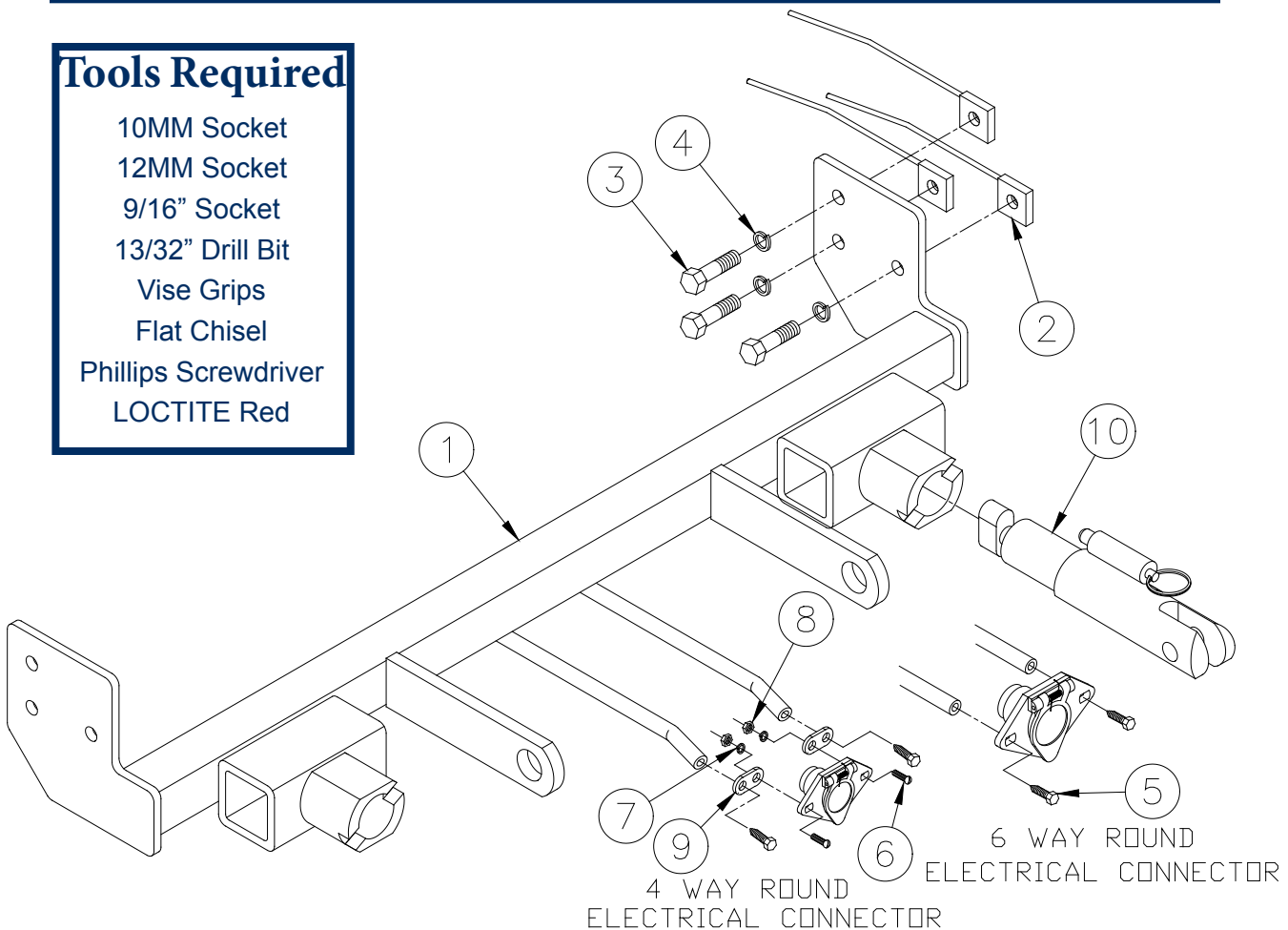

Important:

Use only genuine factory replacement parts on your baseplate. Do NOT substitute homemade or non-typical parts. If a bolt is lost or in need of replacement, for your safety and the preservation of your baseplate, be sure to use a replacement bolt of the same grade (In most cases it will be Grade 5, please reference the parts list above). Replacement parts may be ordered through your nearest Blue Ox® Dealer or Distributor, or call our 24/7 Customer Care Team at (402)385-3051.

BX3518
2004-05 Suzuki Grand Vitara
2006 Suzuki XL7
Installation Instructions

Removable Tabs:

Motorhome mount tow bars are recommended for use with this baseplate. Due to the design of the removable tabs, the RangeFinder II, Adventurer, and Ambassador tow bars can not be used. The Acclaim tow bar may be used, but will not fold and store on the front of the vehicle. Adapters except for the BX8833 and the BX88151, can not be used with this baseplate.

Instructions:

The upper grille, fascia, bumper bracket, temperature sensor and metal bumper are removed and reinstalled during the baseplate installation. Drilling is required.

The dimensional variations between otherwise identical vehicles can be considerable. While the baseplate was designed for easy installation, it may be necessary to tailor the baseplate slightly to compensate for auto manufacturer's tolerances. These minor adjustments may include filing a hole slightly, bending electrical rods, and/ or bending end plates.

The BX8869 Bulb and Socket Wiring Kit is recommended for this vehicle.

Installation Instructions



1. Remove six pushpins from the top edge of the grille between the headlight assemblies. Pull the lower grille forward to release and set aside to be reinstalled later. Set the pushpins aside to be reinstalled later. **2005 Models: will only have four pushpins to remove.**



2. Remove three pushpins from the fascia just below the grille area. **2005 Models: will have seven pushpins to remove.**

BX3518
2004-05 Suzuki Grand Vitar
2006 Suzuki XL7
Installation Instructions



3. Using a 10MM socket, remove one metric bolt and two pushpins from just forward of the front tires. Do this to both sides of the vehicle. Set metric bolts and pushpins aside to be reinstalled later.



4. Using a 10MM socket remove three metric bolts and for Phillips head screws on the bottom edge of the fascia. **2004 Models Only.**



5. Remove two pushpins from the fascia's lower edge, 2004 Models Only. Pull the fascia forward, disconnect the electrical lines on the fog lights and set aside to be reinstalled later. Set the pushpins aside to be reinstalled later.



6. Using a 10MM socket, remove two metric bolts from just below the metal bumper, from the center bumper support. Set the metric bolts and bumper support aside to be reinstalled later.

BX3518
2004-05 Suzuki Grand Vitar
2006 Suzuki XL7
Installation Instructions

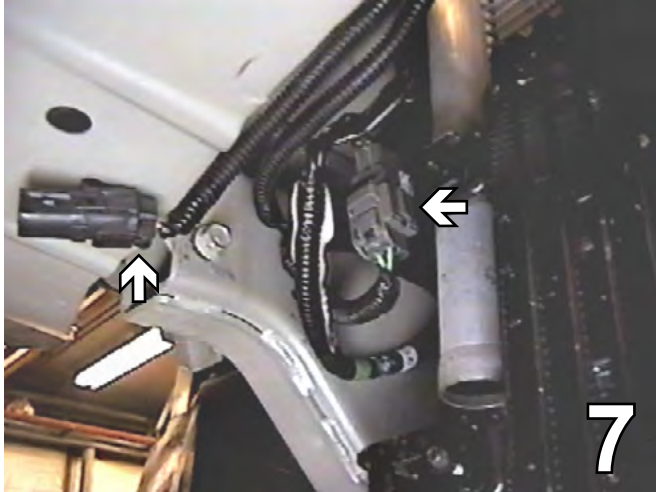

7. Disconnect the electrical sensor from the metal bumper and wiring harness from the frame. Tie the harness and sensor up away from the frame area.

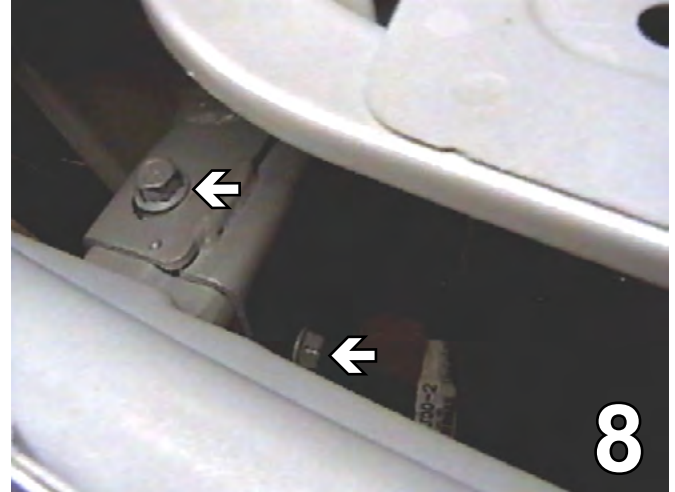

8. Using a 12MM socket, remove two metric bolts from the top and lower frame end. Do this to both sides of the vehicle. Pull metal bumper forward to remove. Set metric bolts and metal bumper aside to be reinstalled later.

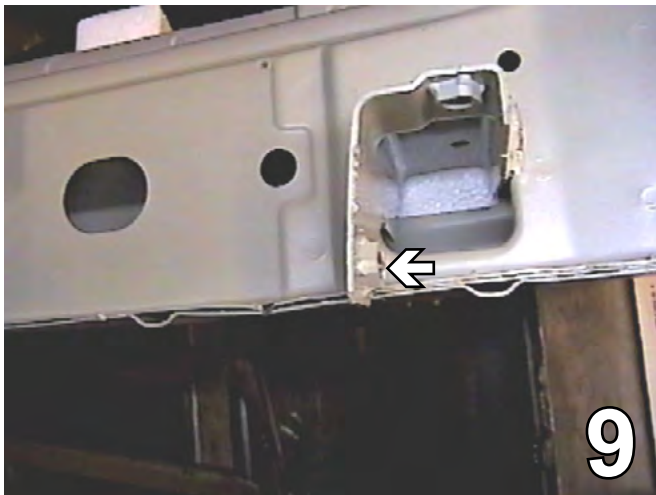

9. Using the flat chisel, remove one square nut from the bumper bracket. Do this to both sides of the vehicle.

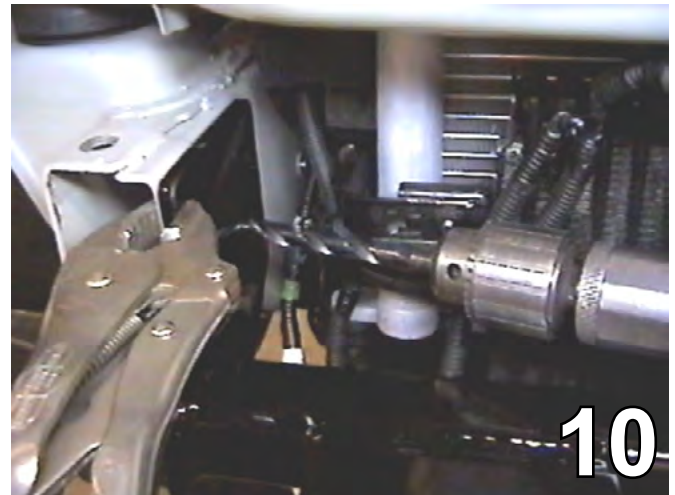

10. Using the vise grip, clamp the baseplate to the frame, align the lower front hole of the baseplate with existing hole for the bumper bolt. This should allow baseplate to extend 1/8" forward of the frame end while maintaining a level position. Using the baseplate as a template, drill all holes into the frame with the 13/32" drill bit. Do this to both sides of the vehicle.

BX3518
2004-05 Suzuki Grand Vitara
2006 Suzuki XL7
Installation Instructions



11. Insert the nutplate into the end of the frame to align it with the two back drilled holes. Tighten the 3/8" bolts and lock washers, according to the drawing on page 2.

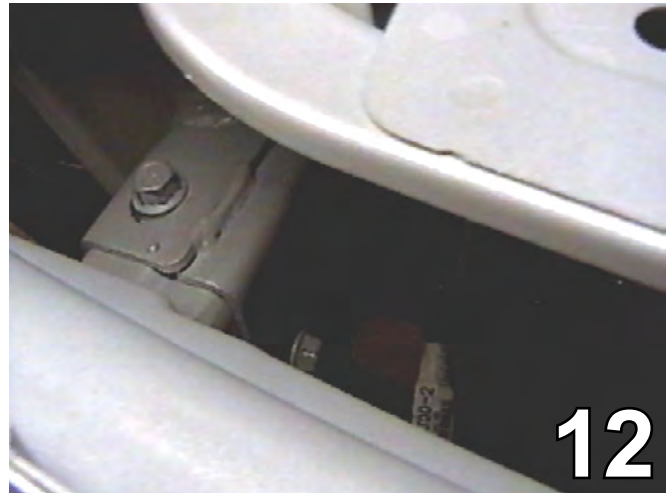

12. Install the metal bumper to its original position and tighten the two top bolts with the 12MM socket. Please refer to the LOCTITE note to the left.

BE SURE TO USE LOCTITE® RED ON ALL BOLTS BEFORE TIGHTENING. TIGHTEN ALL BOLTS ACCORDING TO THE TORQUE CHART ON THE FRONT PAGE OF THESE INSTRUCTIONS OR ON PAGE 3 OF THE BASEPLATE TOWING GENERAL INSTRUCTIONS.

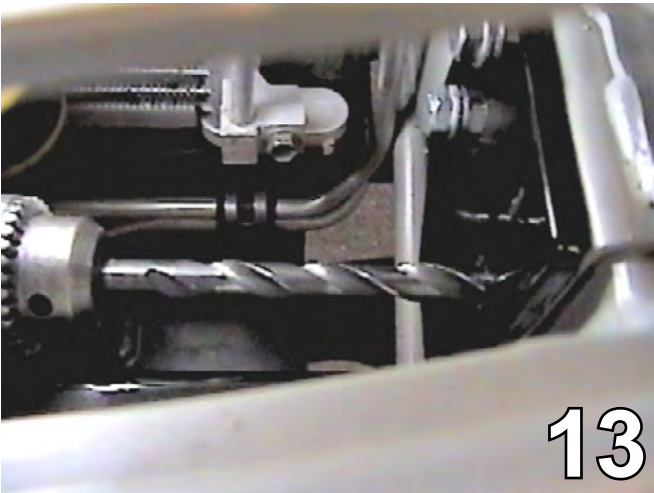

13. Using the baseplate as a template, drill out the front lower existing hole on the frame and into the bumper bracket with the 13/32" drill bit. Insert the nutplate into the frame end to align with the drill hole. Do this to both sides of the vehicle. Please refer to the LOCTITE note above.

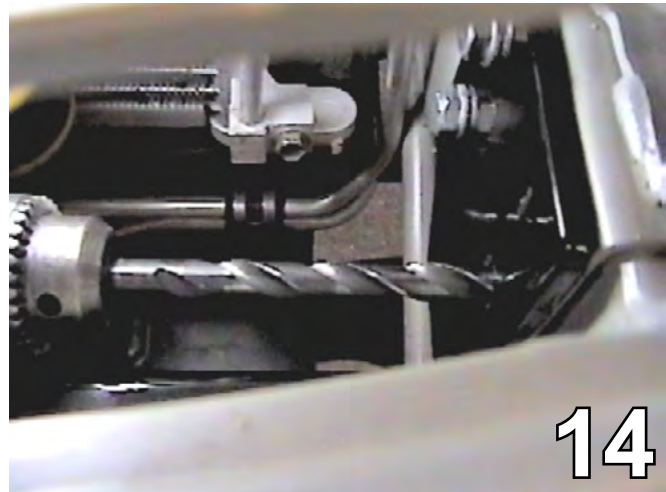

14. Reinstall the lower bumper bracket, temperature sensor, fascia and upper grille.

Be sure that ALL electrical connections are plugged in properly and functioning BEFORE installing the fascia.

BX3518
2004-05 Suzuki Grand Vitara
2006 Suzuki XL7
Installation Instructions

Install the tow bar and safety cables according to the instructions included in their packages.

Do not substitute other devices if the tow bar pin and clip are lost.

DEALER OR INSTALLER: BE CERTAIN THE USER RECEIVES THE INSTRUCTION SHEETS.

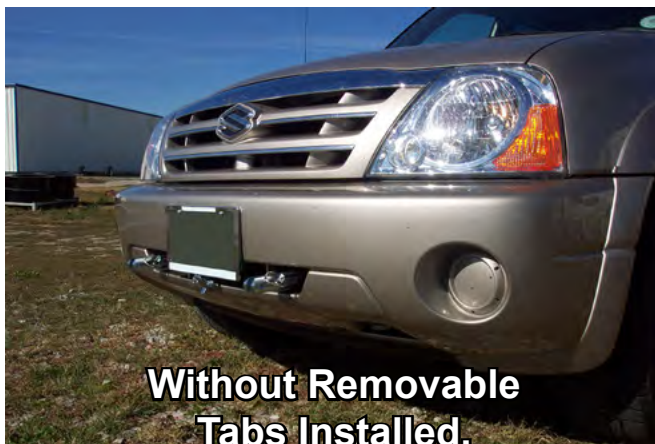
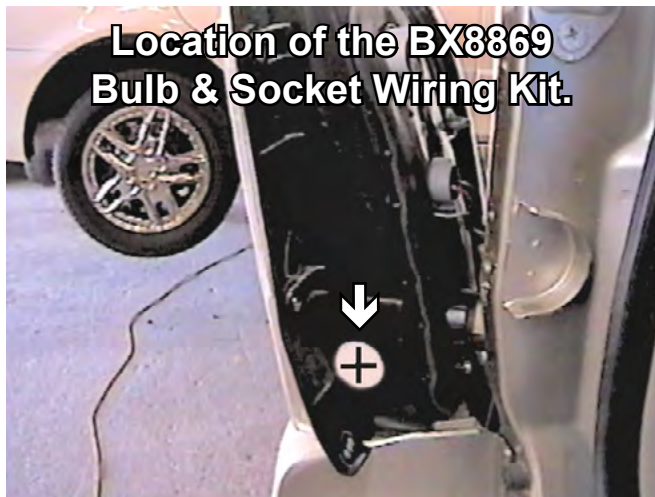

CUSTOMER SERVICE COMMITMENT

Blue Ox is committed to providing you with exceptional customer care throughout your lifetime with our products. Our team is here to assist you with any questions you may have regarding the performance of your product. Simply call 1-800-228-9289 and you can speak with our customer care team.

Additionally, please visit our website to see which rallies our Destination America team will be attending. For a nominal fee, our service technician will service your towing system to ensure it's in proper working condition. Also as a commitment to our customers, should you visit our factory you can stay at our full service Blue Ox campground at no charge along with enjoying a factory tour.

Again thank you for being our customer and for the confidence you have shown in the performance of our products. It is because of customers like you we enjoy the success we have today.



© 2005, 06 Blue Ox
One Mill Road, Industrial Park
Pender, Nebraska 68047
Phone: (402) 385-3051
Toll Free: (888) 425-5382
Fax: (402) 385-3360
www.blueox.us
11/7/08