



BX2243  
 2006-11 Honda Civic  
 (Incl. EX, LX, DX)  
 Installation Instructions

Serial Number

**Please read BOTH these Installation Instructions and the General Instructions before attempting to install or operate this equipment.**

- Blue Ox® towing products and accessories are intended to be installed by Blue Ox® Dealers who are familiar with our products and have the necessary equipment and knowledge to do "fit work". When necessary Blue Ox® Dealers can be found at [www.blueox.com](http://www.blueox.com) or by contacting our Customer Care Department at (402) 385-3051.
- Many Blue Ox® baseplates are designed to use existing holes and hardware to mount the baseplate to the towed vehicle. Even though bolts are there, do not assume they are adequate for baseplate mounting. Always use hardware supplied in the hardware kit and existing hardware specified in the Baseplate Installation Instructions.

Attachment Tab Height: 14 1/2"  
 Attachment Tab Width: 22"

**Bolt Torque Specifications**  
 Torque in Foot-Pounds for Metric Bolts

Bolt Size	Grade 8.8	Grade 10.9
6MM	6	8
8MM	16	22
10MM	31	40
12MM	54	70
14MM	89	117

Confirm the towability and pre-towing procedures for your vehicle with the owner's manual or contact the vehicle's manufacturer for specific towing procedures.

**Bolt Torque Specifications**  
 Torque in Foot-Pounds for Inch Bolts

Bolt Size	Grade 5	Grade 8
1/4"	10	14
5/16"	19	29
3/8"	33	47
7/16"	54	78
1/2"	78	119
5/8"	154	230



**If the front of your vehicle looks different than this, call us at (402) 385-3051.**

**! WARNING**  
 Failure to read and follow these instructions could result in separation of the towed vehicle from the tow bar, causing property damage, loss of towed vehicle, personal injury or death.

# BX2243 2006-11 Honda Civic (Incl. EX, LX, DX)

## Installation Instructions

### Parts List

Ref. No.	Qty.	Part #	Description
1	1	61-6203	Weldment, Baseplate, BX2243
2	1	61-6207	Weldment, Support, DS, BX2243
3	1	61-6208	Weldment, Support, PS, BX2243
4	1	107-1768	Pipe, 3/8" schd 40 x 3/4"
5	6	61-5208	Weldment, 3/8-16 Nut Plate, w/ 14" Wire
6	2	201-0011	1/2-13 x 1 1/4" Hex Bolt, Grade 5, ZP
7	2	203-0005	1/2" Flat Washer, ZP
8	2	203-0012	1/2" Lock Washer, ZP
9	2	202-0005	1/2-13 Hex Nut, ZP
10	14	201-0440	3/8-16 X 1 1/2" Hex Bolt, Grade 5, ZP
11	14	203-0010	3/8" Lock Washer, ZP
12	8	202-0003	3/8-16 Hex Nut, ZP
13	1	201-0655	6MM-1.0 x 30MM Hex Bolt, Grade 8.8, ZP
14	1	201-0702	6MM-1.0 x 45MM Hex Bolt, Grade 8.8, ZP
15	2	203-0008	1/4" Lock Washer, ZP
16	2	203-0001	1/4" Flat Washer, ZP
17	2	201-0979	#12-14 x 1" Self Drilling Screw, ZP
18	2	201-0192	#10-32 x 1/2 Slot, Rd. Hd. Screw
19	2	203-0054	#10 Lock Washer
20	2	202-0047	#10-32 Hex Nut
21	2	101-5822	Adapter, 4 Way Connector
22	2	62-3468	Attachment. Assembly, SF/SB (R)
	2	226-0046	Baseplate Safety Cable, 36" CL III (NS)
	4	229-0359	Quicklink, 3/8, ZP (Not Shown)
	2	290-0437	Cap Plug (Not Shown)

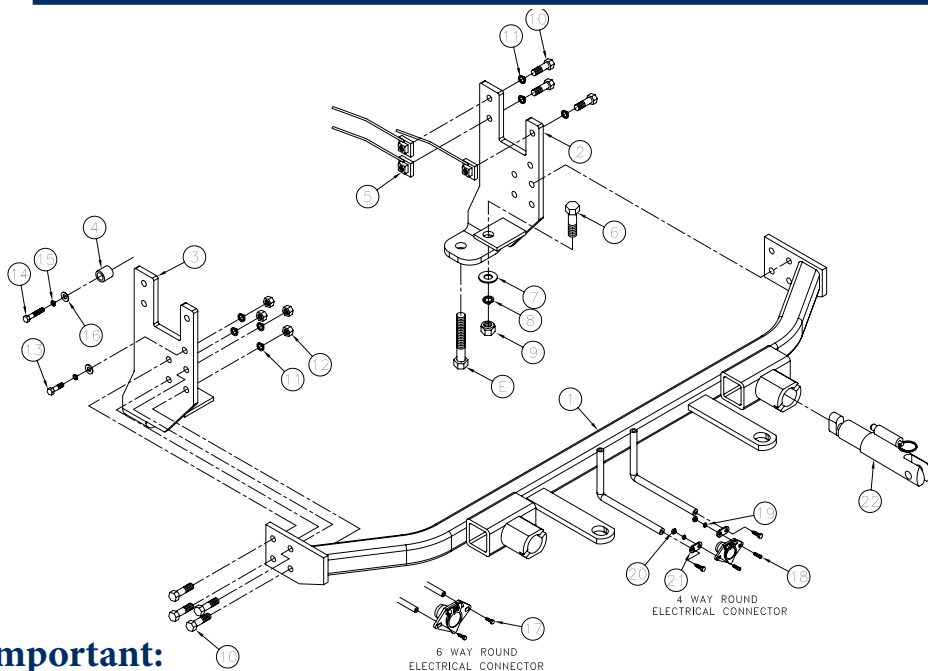

### Tools Required

- T30 Torx Socket
- 14MM Socket
- 10MM Socket
- 17MM Socket
- 12MM Socket
- 9/16" Socket
- 13/32" Drill Bit
- Phillips Screwdriver
- Utility Knife
- Vise Grips
- Reciprocating Saw
- LOCTITE Red
- Hack Saw Blade

### Important:

Use only genuine factory replacement parts on your baseplate. Do NOT substitute homemade or non-typical parts. If a bolt is lost or in need of replacement, for your safety and the preservation of your baseplate, be sure to use a replacement bolt of the same grade. In most cases it will be Grade 5. Please reference the parts list above. Replacement parts may be ordered through your nearest Blue Ox® dealer or distributor, or call our Customer Care Team at (402)385-3051. Failing to follow and/or altering these installation instructions in either installation or required equipment will void the manufacturer's warranty.

BX2243  
2006-11 Honda Civic  
(Incl. EX, LX, DX)  
Installation Instructions

## Attachment Tabs:

Due to the design of the removable tabs, the RangeFinder II, Acclaim and Ambassador tow bars can not be used. Adapters, except the BX8833 and BX88151, can not be used with this baseplate.

## Instruction Notes:

The front fascia, styrofoam bumper, metal bumper, horn bracket, air baffle and windshield washer reservoir are removed and reinstalled during baseplate installation. Drilling is required.

The dimensional variations between otherwise identical vehicles can be considerable. Although the baseplate was designed for easy installation, it may be necessary to tailor the baseplate slightly to compensate for auto manufacturer's tolerances. These minor adjustments may include filing a hole slightly, bending electrical rods or bending end plates.

The BX8848, 4 Diode Wiring Kit is recommended for this vehicle.

Use a 12 Volt D. C. continuity lamp tester to insure the BX8848 will function properly.

Handling of some cosmetic parts when installing this product may require the use of protective covers, rags, specialty tools, etc. to prevent damage.

## Installation Instructions:



1. Remove two push pins from the top of the fascia. Set push pins aside to be reinstalled later.



2. To the rear of the driving light, remove a Christmas tree pushpin. Set pushpin aside to be reinstalled later. Do this to both sides of the vehicle.

3. Lift the black plastic cover. Set aside to be reinstalled later.



BX2243  
2006-11 Honda Civic  
(Incl. EX, LX, DX)  
Installation Instructions

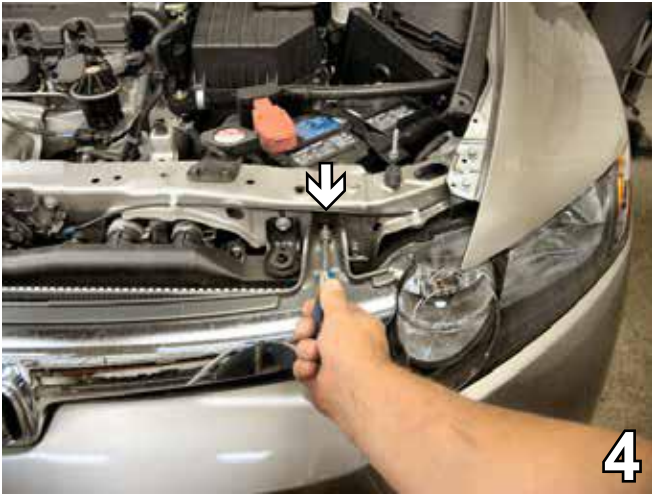

4. Above the grille, next to the radiator support bracket, use a T30 Torx Socket to remove the metric bolt. Do this to both sides of the vehicle. Set screws aside to be reinstalled later.



5. Just forward of the front tire, in an opening between the front fascia and the wheel well, use a Phillips screwdriver to remove the screw. Do this to both sides of the vehicle. Set screws aside to be reinstalled later.



6. Along the bottom edge of the fascia, remove eight push pins, as indicated by the white arrows in the photo above. Do not remove the pushpin found second from either outer edge of the fascia as indicated by the grey arrow in the photo above.



7. On the driver's side, use a 10MM socket to remove two metric bolts securing the air baffle. Pull down to remove. Set bolts and air baffle aside to be reinstalled later.

BX2243  
2006-11 Honda Civic  
(Incl. EX, LX, DX)  
Installation Instructions

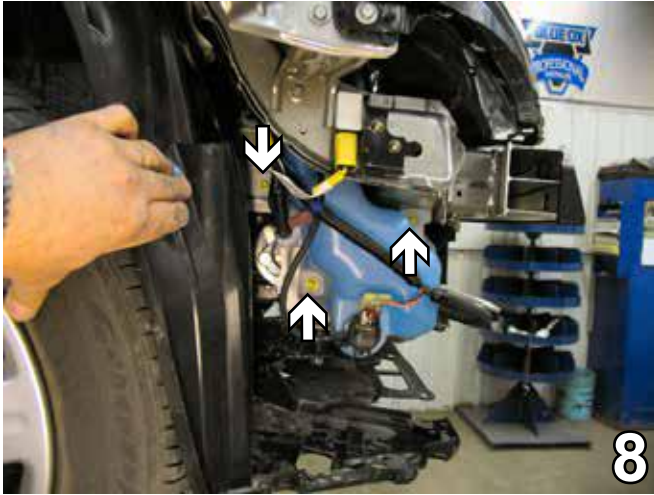

8. On the passenger's side, disconnect and plug the windshield washer reservoir hoses. Disconnect the electrical cable of the windshield washer reservoir pump. Using a 10MM socket, remove three metric bolts from the reservoir. Move the reservoir down and guide the hoses out through the loops found near the top of the windshield washer reservoir. Set bolts and reservoir aside to be reinstalled later.



9. To remove the Styrofoam bumper, pull it forward to release it from the metal bumper.

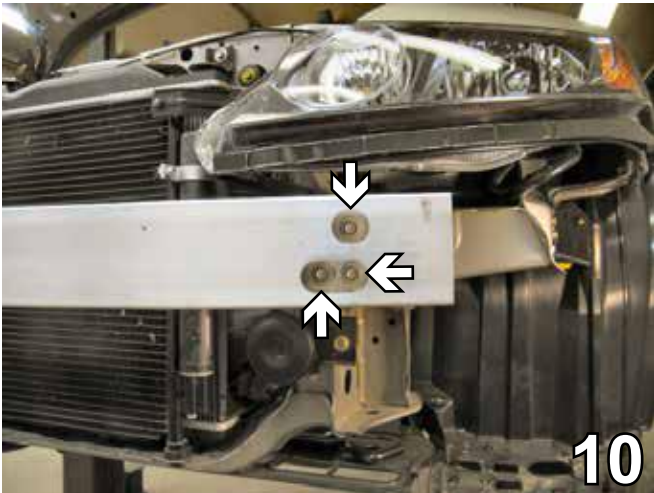

10. Using a 12MM socket, remove three metric bolts from the metal bumper. Do this to both sides of the vehicle. Pull the metal bumper forward. Set metal bumper and bolts aside to be reinstalled later.



11. Using a 12MM socket, remove three metric bolts from the bumper bracket to gain access to the frame rail. Do this to both sides of the vehicle. Set bolts and brackets aside to be reinstalled later.



BX2243  
2006-11 Honda Civic  
(Incl. EX, LX, DX)  
Installation Instructions



12. On the passenger's side, use a 10MM socket to remove a ground wire from the frame rail. Relocate the ground wire to the rear of the frame extension. The grey arrow is the existing location of the bolt, the white arrow shows where it will be relocated.



13. Using a reciprocating saw, cut the lip found at the bottom of the radiator support (dotted lines in graphic) to gain access to the area beneath it. Do this to both sides of the vehicle.

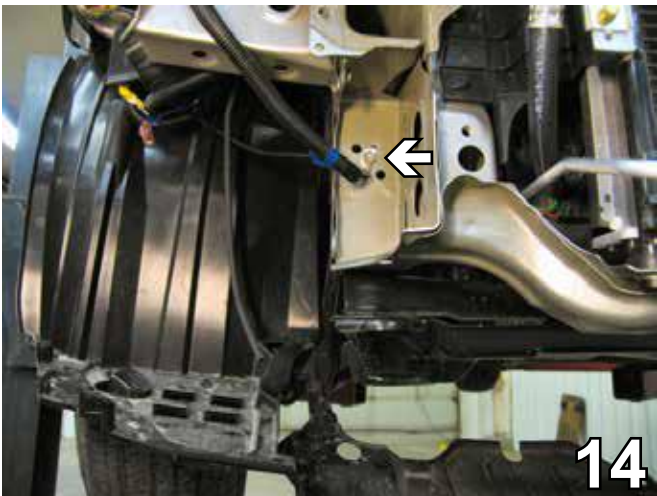

14. Using a 10MM socket, remove a ground wire from the forward facing section of the radiator support on the passenger's side.



15. Relocate and secure the ground wire to the upper rear section of the frame rail on the passenger's side.

BX2243  
2006-11 Honda Civic  
(Incl. EX, LX, DX)  
Installation Instructions



16. Using the 12MM socket, remove the metric bolt from the horn shield on the radiator support on the passenger's side. Hang horn over the lower radiator support ensuring it is out of the way.



17. Using the 12MM socket, remove the metric bolt from the lower part of the horn shield. Set shield aside. It will not be reinstalled.

**CAUTION:**

Do steps #19-21 to the driver's side first.  
Do **NOT** remove the lower suspension bolt on the passenger's side, until driver's side bolt is reinstalled.  
Doing so could cause the forward drive train to become unstable and fall out.



18. Underneath the driver's side, using a 17MM socket, remove the metric bolt from the lower suspension.



19. On the driver's side, place the support plate against the radiator support and frame. Guide upward until it surrounds the frame side extension. Hold the endplate steady and insert the existing metric bolt, from step 19, underneath the endplate and up into the bolt hole for the lower suspension, as indicated by the white arrow in the photo above. Tighten with the 17MM socket. Do not over tighten as the endplate may need minor adjustments.



BX2243  
2006-11 Honda Civic  
(Incl. EX, LX, DX)  
Installation Instructions



20. Align support plate so  $\frac{1}{2}$ -13 x  $1\frac{1}{4}$ " hex bolt can be inserted into the support plate and through the bottom of the radiator support. Tighten with  $\frac{1}{2}$ " flat washer,  $\frac{1}{2}$ " lock washer, and  $\frac{1}{2}$ -13 hex nut. Finish tightening the metric bolt under the lower suspension.

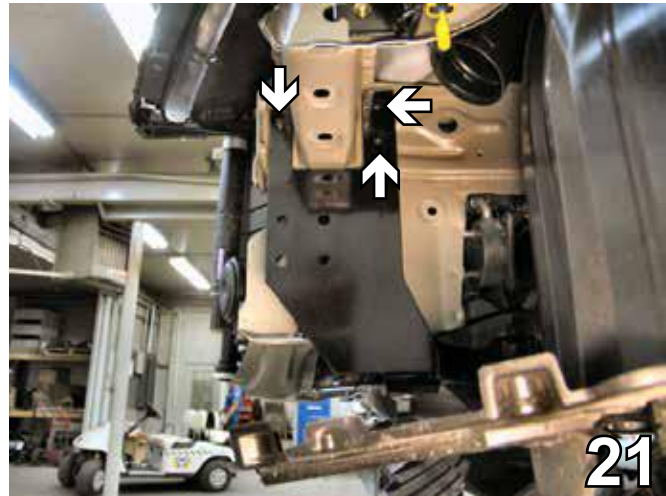

21. Using the support plate as a template, drill three holes into the frame rail with a  $\frac{13}{32}$ " drill bit. Do this to both sides of the vehicle.

**\*\*BE SURE TO USE LOCTITE® RED ON ALL BOLTS BEFORE TIGHTENING. TIGHTEN ALL BOLTS ACCORDING TO THE TORQUE CHART ON THE FRONT PAGE OF THESE INSTRUCTIONS OR ON PAGE 3 OF THE BASEPLATE TOWING GENERAL INSTRUCTIONS.**

When using power drills be aware of the dangers of torque and drill bit length.



22. The upper-most hole in previous step requires drilling at an approximate 45 degree angle.



23. Insert 3/8-16 nut plates through the frame rail opening and align with the three drilled holes. Insert 3/8-16 x  $1\frac{1}{2}$ " hex bolts and 3/8" lock washers and tighten. Do this to both sides of the vehicle.



BX2243  
2006-11 Honda Civic  
(Incl. EX, LX, DX)  
Installation Instructions



24. Slide the baseplate endplate to the outside of the support plate and align with the existing four holes of the support plate. Ensure baseplate is level with the vehicle and tighten all bolts.

**NOTE:** not every bolt hole may align properly. Insert the bolts to the holes that are aligned properly first. Then, ream out remaining bolt holes with 13/32" drill bit and insert bolts.

28. Attach the permanent baseplate safety cables to the provided convenience link on the baseplate. Secure the cables to a solid piece of the frame. Do this to both sides of the vehicle.



26. On the backside of the fascia, using a utility knife, cut an opening to allow for the fog lights when reinstalling the front fascia. Make a vertical cut of one inch. Make two horizontal cuts (shown) of approximately two inches. Do this to both ends of the fascia.

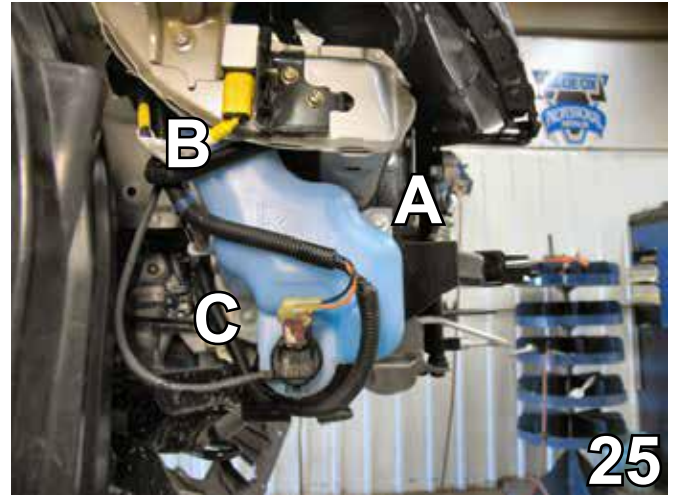

25. Place the windshield washer back to its original position on the passenger's side. Insert the 6MM-1.0 x 30MM hex bolt and fasten with the 1/4" flat washer and 1/4" lock washer (A in photo above). Insert and tighten original metric bolt removed earlier (hidden behind hoses in photo above - B). Insert 6MM-1.0 x 45MM hex bolt and fasten with the 1/4" flat washer and 1/4" lock washer using the 3/8" pipe spacer between the washer reservoir and the existing location on the frame. (C in photo above).



27. Align the fascia to its original position and, using a hack saw blade, trim necessary openings in the grille for the attachment tabs and convenience links.

28. Reinstall the bumper, air baffle, and fascia inserting all push pins, screws, and bolts. The installation of the baseplate is now complete.

BX2243  
2006-11 Honda Civic  
(Incl. EX, LX, DX)  
Installation Instructions

Install the tow bar and safety cables according to the instructions when demonstrating this to the customer. Be sure to include all the contents and packages.

Do **NOT** substitute other devices if the tow bar pins and clips are misplaced.

**DEALER or INSTALLER:**

**Be certain the user receives the instruction sheets for their products.**

**CUSTOMER SERVICE COMMITMENT**

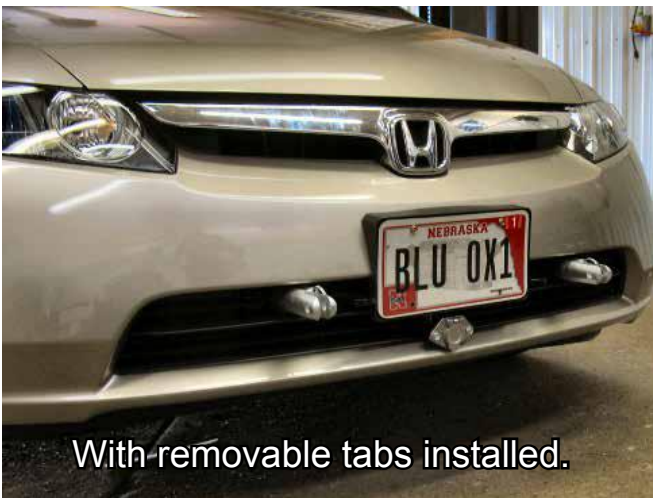

Blue Ox is committed to providing you with exceptional customer care throughout your lifetime with our products. Our team is here to assist you with any questions you may have regarding the performance of your product. Simply call (402) 385-3051 and you can speak with our customer care team.

Additionally, please visit our website to see which rallies our Destination America team will be attending. For a nominal fee, our service technician will service your towing system to ensure it's in proper working condition. Also, as a commitment to our customers, should you visit our factory you can stay at our full service Blue Ox campground at no charge along with enjoying a factory tour.

Again, thank you for being our customer and for the confidence you have shown in the performance of our products. It is because of customers like you we enjoy the success we have today.

If the baseplate is in an accident, it must be replaced. **DO NOT** use it again! An accident can cause unseen damage and using it again could result in more damage or serious injury. **DO NOT** use the baseplate if it is damaged or missing parts.



© 2005,06, 07, 09, 10, 11 Blue Ox  
One Mill Road, Industrial Park  
Pender, Nebraska 68047  
Phone: (402) 385-3051  
Fax: (402) 385-3360  
www.blueox.com



# General Information

1. Ensure that your product(s) are registered online at [www.blueox.com](http://www.blueox.com). It is crucial to register your product(s) so that you may be alerted of product offerings, updates, upgrades, maintenance and safety bulletins, and/or recalls.
2. **It is the owner's responsibility to inspect all towing equipment for cracked welds, missing or worn parts and loose bolts before each towing trip.** Be sure to use Loctite® Red on all bolts and tighten to the recommended specifications.
3. **It is the owner's responsibility to hook up all towing equipment per manufacturer's instructions/recommendations.**
4. Remove the attachment tabs when not in use (if applicable).

## Notice To Baseplate Installer

### 1. It is YOUR responsibility to watch for:

- Oil cooler and air conditioner lines
- Electrical wires and hoses
- Missing parts or attaching points on the frame

\*\* If the baseplate is improperly installed and is against a wire or hose, it could cause fluid leaks or electrical shorts some time after the actual baseplate installation.

## Permanent Baseplate Safety Cable Installation

Permanent baseplate safety cables are strongly recommended when towing a vehicle with a tow bar. The principle function of the permanent baseplate safety cables is to prevent the towed vehicle from breaking loose in the event the connection between the frame of the towed vehicle and the baseplate fails or becomes disconnected. The cables must be connected from the baseplate to the frame rail or cross member of the vehicle's frame. The illustrations below show the possible arrangements recommended by Blue Ox®. Each permanent baseplate safety cable must have an adequate weight rating for the towing system. The weight rating of the two (2) cables together will not qualify.

***Do not mount the permanent baseplate safety cables against wires, hoses or brake lines.***

These permanent baseplate safety cables should remain installed as long as the baseplate is installed on the vehicle. Permanent baseplate safety cables are to be used in conjunction with, and NOT a replacement for legally required safety cables attaching the towed vehicle to the towing vehicle.

### OPTION #1

Permanent Baseplate Safety Cables to Cross Member or Frame of Towed Vehicle.

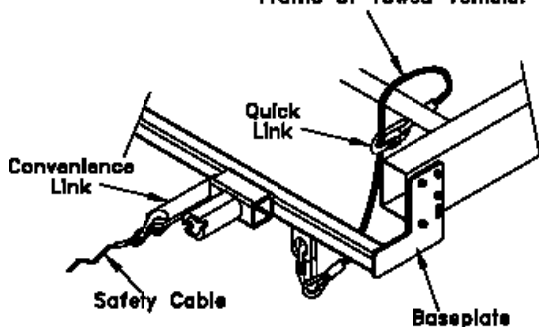

### OPTION #2

Permanent Baseplate Safety Cables to Cross Member or Frame of Towed Vehicle.

